





## Land Use Application #1368720 - Nelson Short Plat

### Project Contact

**Company Name:** Village Life, Inc.

**Name:** Cher Anderson      **Email:** Cher@village-life.net

**Address:** 19020 33rd AVE W 450      **Phone #:** (425) 678-1474  
Lynnwood WA 98036

<b>Project Type</b>	<b>Activity Type</b>	<b>Scope of Work</b>
New	Land Division	Short Subdivision

**Project Name:** Nelson Short Plat

**Description of Work:** 2 lot short plat

### Project Details

**Development Activity**

Subdivision

**Quantity and Size Specifications**

Number of lots	2
----------------	---



PLN2024-0015

**RECEIVED**

Feb 22 2024

CITY OF EDMONDS  
DEVELOPMENT SERVICES  
DEPARTMENT

# LAYTON TREE CONSULTING, LLC

## TREE INVENTORY/ARBORIST REPORT

8514 Bowdoin Way  
Edmonds, WA



**Report Prepared by:**  
**Bob Layton**  
**Registered Consulting Arborist #670**  
**Certified Arborist #PN-2714A**

**February 1, 2024**

*It's all about trees.....*

PO BOX 572, SNOHOMISH, WA 98291-0572 \* 425-220-5711 \* bob@laytontreeconsulting.com

## Table of Contents

Assignment.....	3
Description.....	3
Methodology.....	3
Judging Condition.....	4
Observations.....	4
Tree Protection Guidelines.....	6
Tree Protection Measures.....	7
Tree Retention.....	7
Tree Replacement.....	7
Arborist Disclosure Statement.....	8

## Attachments

Photos, pages 9 - 16

Tree Summary Table

Tree Conditions Map – Existing Conditions

Tree Plan Map



## Assignment

Layton Tree Consulting, LLC was asked to compile an Arborist Report for a property in Edmonds, located at 8514 Bowdoin Way. The purpose of the report is to satisfy City requirements regarding tree retention and protection associated with the proposed construction of two new single-family residences on the property.

My assignment is to prepare a written report on present tree conditions, which is to be submitted to the City with the development application materials.

This report covers all of the criteria set forth under the City of Edmonds tree regulations (EMC 23.10.060 Tree retention associated with development activity). The required retention is 30% of significant trees. A significant tree means a tree that is at least six inches in diameter at breast height (DBH) as measured at four and one-half feet from the ground.

Date of Field Examination: January 5<sup>th</sup>, 2024

## Description

Nine significant trees were identified and assessed on the subject property. These are comprised of a mix of planted ornamental species and native species. Subject trees are located on the west and south perimeters of the property.

A tree summary table is attached which provides detailed information for each assessed tree. Subject trees were identified in the field with a numbered aluminum tag attached to the lower trunk. These tag numbers correspond with the tree numbers on the attached summary table and map.

An additional eight off-site or neighboring trees were also assessed. Seven are located within a proximity of the west property line. The other is located off of the northwest property corner within the street right-of-way of Bowdoin Way.

## Methodology

Each tree in this report was visited. Tree diameters were measured by tape. The tree heights were measured using a Spiegel Relaskop. Each tree was visually examined for defects and vigor. The tree assessment procedure involves the examination of many factors:

- The crown or canopy of the tree is examined for current vigor/health by examining the foliage for appropriate color and density, the vegetative buds for color and size, and the branches for structural form and annual shoot growth; and the overall presence of limb dieback and/or any disease issues.
- The trunk or main stem of the tree is inspected for decay, which includes cavities, wounds, fruiting bodies of decay (conks or mushrooms), seams, insect pests, bleeding or exudation of sap, callus development, broken or dead tops, structural defects and unnatural leans. Structural defects can include but are not limited to excessive or unnatural leans, crooks, forks with V-shaped crotches, multiple attachments.

- The root collar and exposed surface roots are inspected for the presence of decay, insect damage, as well as if they have been injured or wounded, undermined or exposed, or the original grade has been altered.

Based on these factors a determination of condition and viability is made.

### Judging Condition

The three condition categories are described as follows:

Good – free of significant structural defects, no disease concerns, minor pest issues, no significant root issues, good structure/form with uniform crown or canopy, foliage of normal color and density, average or normal vigor, will be wind firm if isolated or left as part of a grouping or grove of trees, suitable for its location

Fair – minor to moderate structural defects not expected to contribute to a failure in near future, no disease concerns, moderate pest issues, no significant root issues, asymmetric or unbalanced crown or canopy, average or normal vigor, foliage of normal color, moderate foliage density, will be wind firm if left as part of a grouping or grove of trees, cannot be isolated, suitable for its location

Poor – major structural defects expected to cause fail in near future, disease or significant pest concerns, decline due to old age, significant root issues, asymmetric or unbalanced crown or canopy, sparse or abnormally small foliage, poor vigor, not suitable for its location

A viable tree means a significant tree that a qualified professional has determined to be in good health, with a low risk of failure due to structural defects, is windfirm if isolated or remains as part of a grove, and is a species that is suitable for its location.

### Observations

Tree #1 is a semi-mature to mature Lawson cypress. It is comprised of three stems or trunks, which fork at ground level or the root crowns. There is a moderate buildup or accumulation of included or embedded bark between the forked trunks/stems. Vigor is good, foliage is of normal color and density. Condition is 'good'.

Trees #2 and #3 are young to semi-mature cultivated varieties of Lawson cypress. Both are of good vigor. These are both clusters of small stems. Tree #2 has a significant lean. Some smaller stems have recently fallen over. Condition is 'fair'. Tree #3 has developed better structural form. Condition is 'good'.

Tree #4 is a semi-mature to mature Japanese maple. It has developed typical form for the species and appears to be of good vigor. No concerning issues were observed. Condition is 'good'.

Tree #5 is a mature Western red cedar. It is comprised of two large codominant (equal diameter) trunks. There is a significant buildup or accumulation of included or embedded bark and associated seam between the forked trunks. Stems have developed natural leans away from each other. Vigor is good. Overall condition is rated as 'fair'.

Tree #6 is a semi-mature Sitka spruce. The lower trunk forks at roughly 8-feet above ground into codominant stems or trunks. There is no noteworthy buildup of included or embedded bark between the forked trunks. Stems are upright or vertical with no leans. Vigor is good. Condition is 'good'.

Trees #7 and #8 are semi-mature Lawson cypress. They have developed typical form for the species and are of good vigor. No concerning issues were observed. Condition is 'good'.

Tree #9 is a semi-mature Western red cedar. It is also comprised of two stems or trunks. One of the forked stems is subdominant. There is no noteworthy buildup of included or embedded bark between the forked trunks. Stems are upright or vertical with no lean. Vigor is fairly good. Condition is 'good'.

#### Off-site/Neighboring Trees

Tree #101 is a semi-mature Western red cedar. This is a large cluster comprised of seven stems or trunks. There is a moderate buildup or accumulation of included or embedded bark and associated seams between some of the forked trunk attachments. Vigor is good. Overall condition is rated as 'good'.

Tree #102 is a semi-mature cluster of Lawson cypress. Vigor is good. No concerning issues were observed from the subject property side. Condition is 'good'.

Trees #103 and #104 are semi-mature Western red cedar. No concerning issues were observed from the subject property side. Condition is 'good'.

Tree #105 is a young to semi-mature Douglas fir, located close to the west property line. Vigor is good. No concerning issues were observed from the subject property side. Condition is 'good'.

Tree #106 appears to be a semi-mature English walnut. No concerning issues were observed from the subject property side. Condition is 'good'.

Tree #107 is a young to semi-mature red oak variety. No concerning issues were observed from the subject property side. Condition is 'good'.

Tree #108 is a semi-mature native bitter cherry. It has developed poor structural form. The lower trunk forks into codominant stems. The forked attachment appears weak. Condition is 'fair'.

### **Discussion/Recommendations**

The attached tree plan map indicates the actual driplines of subject trees to be retained and neighboring trees to be protected. Driplines and limits of disturbance measurements are provided on the tree summary table. "Limits of disturbance" means the boundary between the area of minimum protection around a tree and the allowable site disturbance. The attached map also indicates the recommended location of the tree protection barrier.

Trees #1 > #5 will be compromised by new construction/re-development of the property. Removal is proposed. The removal of these trees is not expected to have any adverse effects on trees to remain at the site.

Trees #6 > #9 will be retained. These are well-positioned for successful retention at the back of the property. No work is proposed within a proximity of them.

The Lot 1 house and driveway have been moved as far east as possible to minimize impacts to neighboring trees to the west. Position the tree protection barrier just beyond the driplines as shown on the attached tree plan map.

The most noteworthy impacts will be to neighboring Tree #105. The cut for the new foundation will be roughly 5-feet from the property line, inside its dripline and normal limits of disturbance. Severing roots at the foundation cut east of the tree would not be expected to have any adverse impacts on its structural stability. This is a young to semi-mature specimen. This is a hardy species and tolerable of noteworthy impacts. It is expected to remain viable post construction. The project arborist should be on-site to oversee the foundation excavation so any impacted roots can be properly pruned and to minimize overall impacts. The cut stump of Tree #5 shall be grinded down to just below grade to minimize impacts to Tree #105

The back of the property has a major infestation of invasive Himalayan blackberry. All finish landscape work within the tree protection zones shall be accomplished utilizing hand-labor only. Simply finish the landscape within the tree protection zones by manually removing the blackberry and adding a 3 to 4-inch layer of organic woodchip mulch.

### Tree Protection Guidelines

Tree protection fencing shall be positioned around any retained trees or off-site protected trees prior to the start of work or bringing any heavy equipment onto the site. This will help to define clearing limits and protect soils and surface roots. Existing grades within the tree protection fenced area shall not be altered. Position fencing as shown on the attached map.

Any excavation within the driplines of retained trees and/or the neighboring trees shall be monitored by the project arborist so necessary precautions can be taken to minimize overall impacts. Any roots damaged during site work outside of the tree protection area shall be pruned clean at sound tissue prior to backfilling or finishing areas. Sound tissue is where the root is undamaged and the bark is completely intact with the root. This will help roots to seal off potential decay and allow them to sprout new growth. Any disturbed areas near protected trees shall be watered weekly during the dry season of June through September. This will help to create a favorable environment for new root growth and reduce the overall stress associated with root loss and disturbance.

Simply finish the landscape within the tree protection areas by cutting/hand-pulling any unwanted vegetation and applying a 2 to 4-inch covering of organic mulch/beauty bark. Existing lawn around the trees could be maintained if desired. Avoid large plantings, irrigation trenches and the construction of hardscapes within the driplines of retained trees.

## Tree Protection Measures

The following guidelines are recommended to ensure that the designated space set aside for the preserved trees are protected and construction impacts are kept to a minimum. Standards have been set forth under EMC 23.10.070 Tree protection measures during development. Please review these standards prior to any development activity.

- Tree protection fencing shall be erected prior to moving any heavy equipment on site. Doing this will set clearing limits and avoid compaction of soils within root zones of retained trees. Tree protective fencing shall be a minimum height of three feet, visible and of durable construction.
- Excavation limits shall be laid out in paint on the ground to avoid over excavation and unnecessary damage.
- Authorized work or excavation within the driplines of protected trees shall be monitored by a qualified tree professional so necessary precautions can be taken to decrease impacts to tree parts.
- To establish sub grade for foundations, curbs and pavement sections near the trees, soil shall be removed parallel to the roots (away from tree trunks) and not at 90-degree angles to avoid breaking and tearing roots that lead back to the trunk within the drip-line. Any roots damaged during these excavations shall be exposed to sound tissue and cut cleanly with a saw.
- Areas excavated within the driplines of retained trees shall be thoroughly irrigated weekly during dry periods.
- Preparations for final landscaping shall be accomplished by hand within the drip-lines of retained trees. Large equipment shall be kept outside of the tree protection zones at all times.

## Tree Retention

Per 23.10.060 Tree retention associated with development activity. C. Tree Retention Requirements - 30% of the significant viable trees are required to be retained. There are nine viable significant trees on the property requiring the retention of three trees. The proposal is to retain four trees (Trees #6 > #9) which equates to 44% retention.

## Tree Replacement

23.10.080 Tree replacement.

A. Replacement Required. Tree replacement is required for tree cutting permits required by this chapter and/or for tree removal associated with the development types identified in ECDC 23.10.060(A). Each significant tree to be removed shall be replaced as follows:

1. For each significant tree between six inches and 10 inches DBH removed, one replacement tree is required.

2. For each significant tree between 10.1 inches and 14 inches in DBH removed, two replacement trees are required.

3. For each significant tree greater than 14 inches and less the 24 inches in DBH removed, three replacement trees are required.

The project will require 13 new replacement trees. There is available planting space at the front and back of Lot 1, and the back of Lot 2 to sustain the required tree replacement.

Minimum sizes for replacement trees shall be: One-and-one-half-inch caliper for deciduous trees; and six feet in height for evergreen trees. Replacement trees shall be primarily native species.

### Arborist Disclosure Statement

Arborists are tree specialists who use their education, knowledge, training and experience to examine and assess trees, recommend measures to enhance the beauty and health of trees, and attempt to reduce the risks associated with living near trees. Clients may choose to accept or disregard the recommendations of the arborist, or to seek additional advice.

Arborists cannot detect every condition that could possibly lead to the structural failure of a tree. Trees are living organisms that grow, respond to their environment, mature, decline and sometimes fail in ways we do not fully understand. Conditions are often hidden within trees and below ground.

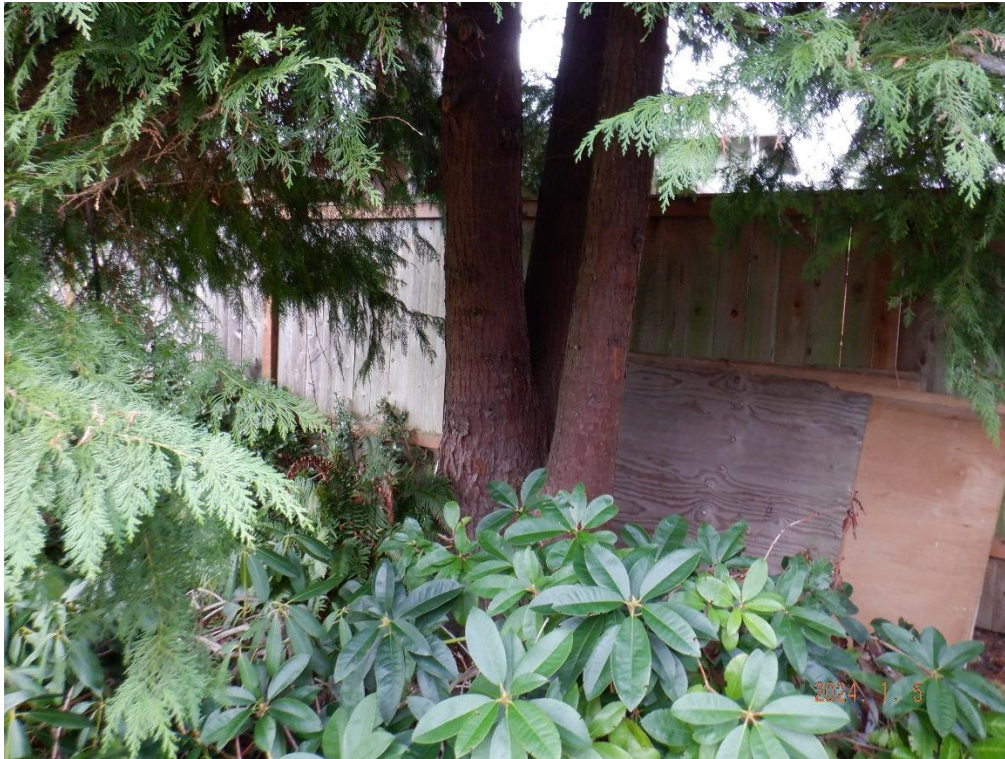
Arborists cannot guarantee that a tree will be healthy and/or safe under all circumstances, or for a specified period of time. Likewise, remedial treatments, like any medicine, cannot be guaranteed. Treatment, pruning and removal of trees may involve considerations beyond the scope of the arborist's services such as property boundaries, property ownership, site lines, disputes between neighbors, and other issues. Arborists cannot take such considerations into account unless complete and accurate information is disclosed to the arborist. An arborist should then be expected to reasonably rely upon the completeness and accuracy of the information provided.

Trees can be managed, but they cannot be controlled. To live near trees is to accept some degree of risk. The only way to eliminate all risk associated with trees is to eliminate all trees.

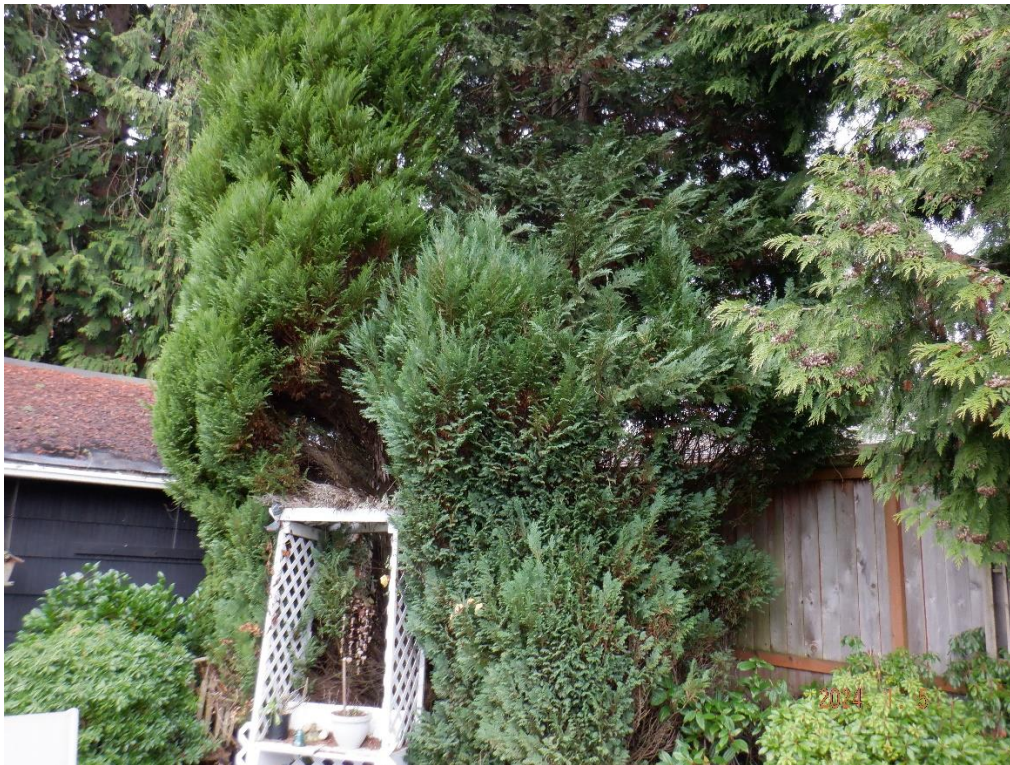


Photo Documentation

Tree #1



Trees #2 and #3 near corner of garage





Tree #5



Tree #5, upper stems





Arborist Report – 8514 Bowdoin Way

Trees #6 > #9 on south perimeter at back of property



Tree #6





Forked trunk of Tree #6



Tree #6, upper crown





Arborist Report – 8514 Bowdoin Way

Trees #7, #8 and #9



Trees #7, #8 and #9





Arborist Report – 8514 Bowdoin Way

Tree #101



Tree #101, lower trunk





Trees #103 and #104



Tree #105, at end of fence





Arborist Report – 8514 Bowdoin Way

Trees #106, #107 and #108



Looking south down east property line, small, non-significant Japanese maples



# RECEIVED

Feb 22 2024

CITY OF EDMONDS  
DEVELOPMENT SERVICES  
DEPARTMENT

**Layton Tree Consulting LLC**

For: Village Life  
Site: 8514 Bowdoin Way

**Tree Summary Table**

Date: 1/5/2024



Tree/ Tag #	Species Common name	Species Scientific name	DBH (inches)	Height (feet)	Drip-Line/Limits of Disturbance (feet)				Health Condition	Structural Condition	Comments	Proposal	Replacement Trees
					N	S	E	W					Required
1	Lawson cypress	<i>Chamaecyparis lawsoniana</i>	14,13,8 (35)	62	12	9	11	8	Excellent	Fair	forked at base, included bark	Remove	3
2	Lawson cypress	<i>Chamaecyparis lawsoniana</i>	9	40	6	6	6	2	Good	Fair	natural lean	Remove	1
3	Lawson cypress	<i>Chamaecyparis lawsoniana</i>	15,9,6 (30)	48	10	10	8	10	Excellent	Good	cluster	Remove	3
4	Japanese maple	<i>Acer palmatum</i>	10,6,6 (22)	20	18	12	14	16	Good	Good	typical form	Remove	3
5	Western red cedar	<i>Thuja plicata</i>	36,32 (68)	90	18	20	22	16	Excellent	Fair	forked at base,seam,natural leans	Remove	3
6	Sitka spruce	<i>Picea sitchensis</i>	38	100	12/14	16	14	16	Good	Good	trunk forks at 8 feet,sound attachment	Retain	
7	Lawson cypress	<i>Chamaecyparis lawsoniana</i>	11,8 (19)	52	8/10	6	4	6	Excellent	Fair	forked at base	Retain	
8	Lawson cypress	<i>Chamaecyparis lawsoniana</i>	17,14 (31)	78	10/12	8	6	6	Excellent	Good	typical form	Retain	
9	Western red cedar	<i>Thuja plicata</i>	34,22 (56)	88	18/18	16	18	16	Good	Good	forked trunk, sound attachment, forked top leaders	Retain	
13													
OFF-SITE TREES													
101	Western red cedar	<i>Thuja plicata</i>	7 - 18 to 24"	80	18	20/20	20/18	18	Good	Fair	multiple (7) trunks, moderate included bark	Protect	
102	Lawson cypress	<i>Chamaecyparis lawsoniana</i>	16,15,13,12	56	10	10	10/10	10	Excellent	Good	cluster	Protect	
103	Western red cedar	<i>Thuja plicata</i>	28	72	12	10	12/12	8	Good	Excellent	close to fence	Protect	
104	Western red cedar	<i>Thuja plicata</i>	28	70	8	12	8/10	14	Excellent	Excellent	close to fence	Protect	
105	Douglas fir	<i>Pseudotsuga menziesii</i>	26	96	6	14	10/10	12	Excellent	Good	natural lean SW	Protect	
106	English walnut	<i>Juglans regia</i>	16	52	18	16	14/14	NA	Good	Good	no concerns	Protect	
107	red oak	<i>Quercus rubra</i>	13	55	10	10	14/12	NA	Good	Good	no concerns	Protect	
108	bitter cherry	<i>Prunus emarginata</i>	11	56	8	10	12/10	NA	Good	Fair	forked trunk, weak attachment	Protect	

Drip-line and Limits of Disturbance measurements from face of trunk

For trees with multiple leaders at four and one-half feet height, the DBH shall be the combined cumulative total of branches greater than six inches diameter at four and one-half feet above the average grade.

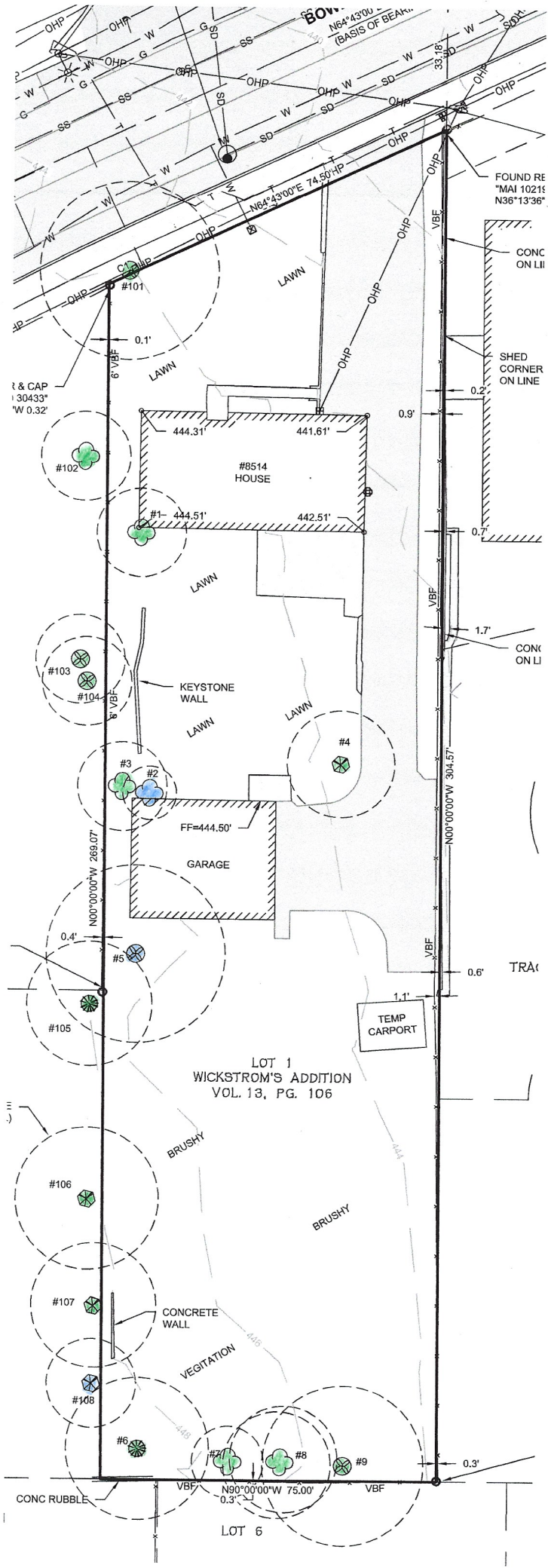


8514 Bowdoin Way  
 TREE CONDITIONS  
 MAP -  
 EXISTING  
 CONDITIONS

**RECEIVED**  
 Feb 22 2024  
 CITY OF EDMONDS  
 DEVELOPMENT SERVICES  
 DEPARTMENT

TREE CONDITIONS

- # - Good
- # - Fair



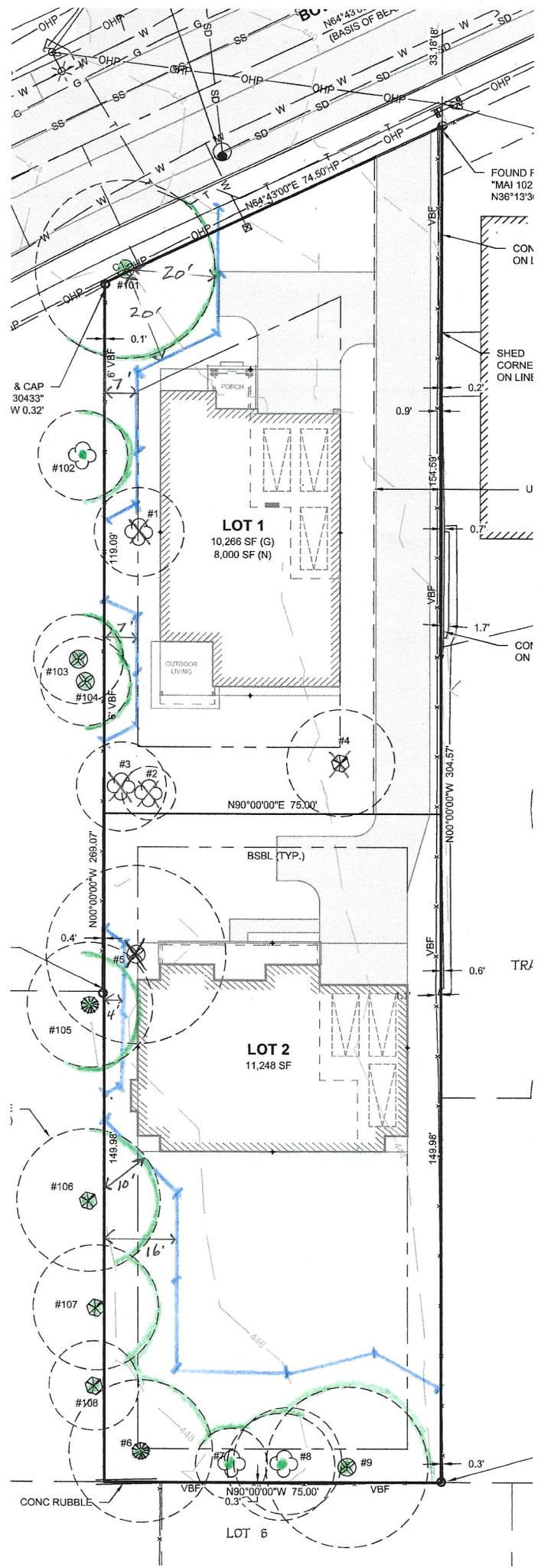
LOT 1  
 WICKSTROM'S ADDITION  
 VOL. 13, PG. 106

LOT 6



8514 BOWDOIN WAY  
TREE PLAN MAP

— DRIPLINE  
— TREE PROTECTION FENCE



**RECEIVED**  
Feb 22 2024  
CITY OF EDMONDS  
DEVELOPMENT SERVICES  
DEPARTMENT

APPROX. SCALE  
1" = 33'



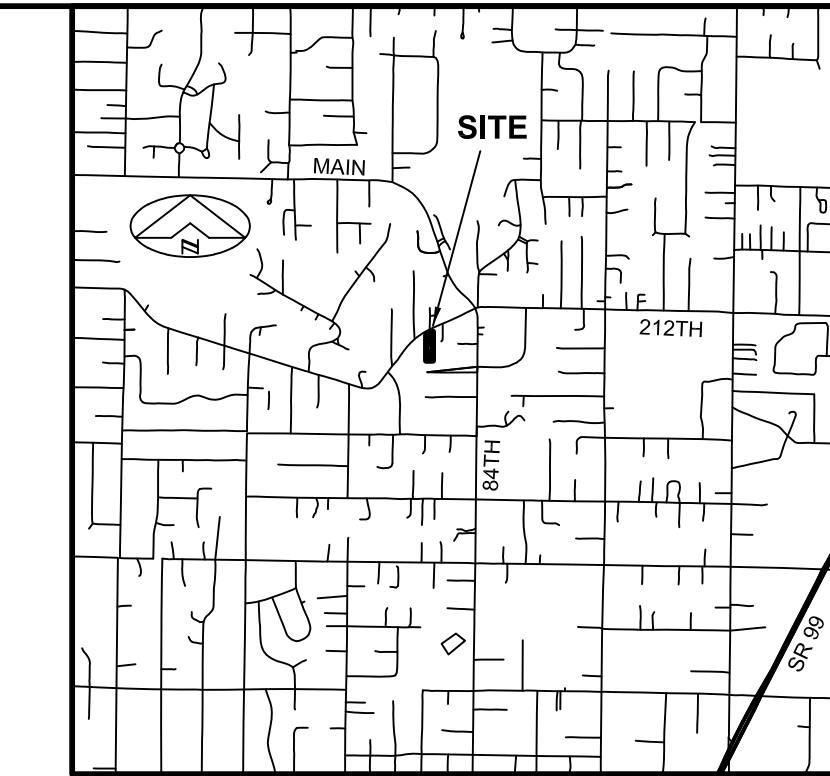
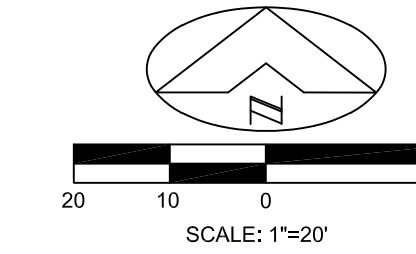
**NELSON SHORT PLAT**

A PORTION OF THE NORTHEAST QUARTER OF THE NORTHWEST QUARTER OF SECTION 30, TOWNSHIP 27 NORTH, RANGE 4 EAST, W.M.

SP S-24-

**CITY OF EDMONDS**  
SNOHOMISH COUNTY, WASHINGTON

**PRELIMINARY SHORT PLAT**

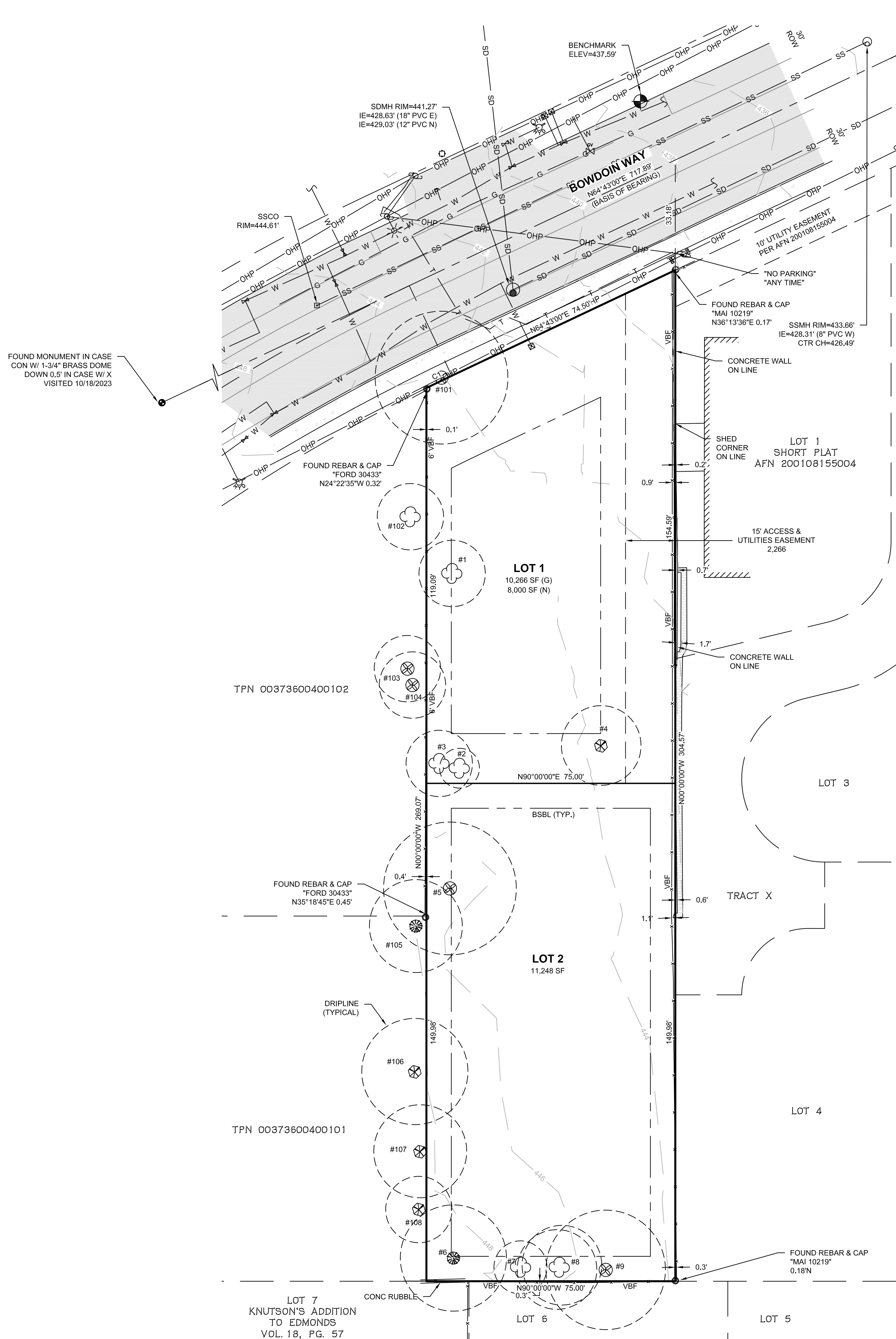


**SITE DATA**

SITE ADDRESS: 8514 BOWDOIN WAY EDMONDS, WA, 98026  
 TAX ACCOUNT NUMBER: 006134-900-001-00  
 EXISTING ZONING: RS-8  
 PROPOSED ZONING: RS-8  
 COMPREHENSIVE PLAN: SINGLE FAMILY-URBAN 1  
 PROPOSED LAND USE: SINGLE-FAMILY RESIDENTIAL  
 SURROUNDING LAND USES: SINGLE-FAMILY RESIDENTIAL  
 GROSS SITE AREA: 21,914 SF (0.49 ACRES)  
 NUMBER OF LOTS PROPOSED: 2  
 UNITS PER ACRE OF LAND: 2 UNITS/0.49 ACRES = 4.1 UNITS PER GROSS ACRE  
 AVERAGE SIZE OF LOTS: 10,757 SF  
 WATER SOURCE/PURVEYOR: PUBLIC/CITY OF EDMONDS  
 SEWAGE DISPOSAL/PURVEYOR: PUBLIC/CITY OF EDMONDS  
 TELEPHONE PURVEYORS: FRONTIER/FINITY  
 POWER/GAS PURVEYORS: PUGET SOUND ENERGY  
 FIRE DISTRICT: SOUTH COUNTY FIRE  
 SCHOOL DISTRICT: EDMONDS SCHOOL DISTRICT NO. 15

CURVE	RADIUS	DELTA ANGLE	ARC LENGTH
C1	543.70'	0°53'36"	8.48'

- LEGEND**
- FOUND MONUMENT AS NOTED
  - FOUND SURVEY MARKER AS NOTED
  - CATCH BASIN T-2
  - WATER VALVE
  - WATER METER
  - FIRE HYDRANT
  - SEWER MANHOLE
  - SEWER CLEAN OUT
  - GAS VALVE
  - POWER METER
  - POWER JUNCTION BOX
  - UTILITY POLE
  - GUY ANCHOR
  - GUY POLE
  - UTILITY POLE MOUNTED LIGHT
  - COMMUNICATIONS RISER
  - MAILBOX
  - SIGN
  - DECIDUOUS TREE (TREE TAG # NOTED)
  - CEDAR TREE (TREE TAG # NOTED)
  - CYPRESS TREE (TREE TAG # NOTED)
  - EVERGREEN TREE (TREE TAG # NOTED)
  - PAVEMENT
  - CONCRETE
  - KEYSTONE WALL
  - VBF VERTICAL BOARD FENCE
  - FENCE LINE
  - SS SEWER LINE
  - SD STORM DRAIN LINE
  - W WATER LINE
  - P UNDERGROUND POWER
  - OHP OVERHEAD UTILITIES
  - T UNDERGROUND COMMUNICATIONS
  - G GAS LINE
  - BSSL BUILDING SETBACK LINE



FOUND MONUMENT IN CASE CONC MON W/ NAIL VISITED 3-18-14 NOT FOUND THIS SURVEY

FOUND MONUMENT IN CASE CONC W/ 1-3/4" BRASS DISK W/ PUNCH DOWN 0.4" IN CASE S 8°28'26"W 3.67' FROM INTX VISITED 10/18/2023

**LEGAL DESCRIPTION**

PER ALTA COMMITMENT FOR TITLE INSURANCE BY CHICAGO TITLE CO., COMMITMENT NUMBER 500144436, DATED JULY 3, 2023:  
 LOT 1, WICKSTROMS ADDITION, ACCORDING TO THE PLAT THEREOF RECORDED IN VOLUME 13 OF PLATS, PAGE 106 RECORDS OF SNOHOMISH COUNTY.  
 SITUATE IN THE COUNTY OF SNOHOMISH, STATE OF WASHINGTON.

**BASIS OF BEARING**

NORTH 63°43'00" EAST BETWEEN FOUND MONUMENTS ALONG THE CENTERLINE OF BOWDOIN WAY PER THE PLAT OF WICKSTROMS ADDITION VOL. 13, PG. 106 AS REFERENCED HEREON.

**DATUM** NAVD 88  
**BENCHMARK**

MAG NAIL & WASHER SET IN NORTH CURB OF BOWDOIN WAY APPROXIMATELY 51.92' NORTH OF THE NORTHEAST PROPERTY CORNER.  
 ELEV=437.59'

**SURVEY REFERENCES**

WICKSTROMS ADDITION VOL. 13, PG. 106  
 RECORD OF SURVEY AFN 202106305002  
 SHORT PLAT AFN 200108155004

**SURVEY NOTES**

EQUIPMENT: 3" OR LESS TOTAL STATION AND GNSS RECEIVER.  
 NETWORK GNSS.  
 METHOD: FIELD TRAVERSE AND WASHINGTON STATE REFERENCE NETWORK GNSS.  
 THE CLOSURES OF THE FIELD TRAVERSE CONDUCTED DURING THIS SURVEY MEET OR EXCEED THE MINIMUM CLOSURE STANDARDS STATED IN WAC 332-130-090.  
 THE TOPOGRAPHIC ELEMENTS AS SHOWN MEET OR EXCEED THOSE REQUIREMENTS STATED IN WAC 332-130-145.  
 ELEVATION CONTOURS ARE SHOWN AT 2' INTERVALS AND DERIVED FROM DIRECT FIELD OBSERVATIONS. ACCURACY IS PER NATIONAL MAPPING STANDARDS.  
 THE INFORMATION SHOWN ON THIS MAP REPRESENTS THE RESULTS OF A SURVEY MADE ON THE INDICATED DATE AND CAN ONLY BE CONSIDERED AS THE GENERAL EXISTING CONDITION AT THAT TIME.

**OWNERS**

DIANNE NELSON  
 8514 BOWDOIN WAY  
 EDMONDS, WA, 98026

**PLAN PREPARER**

ANDREW S. LOFSTEDT  
 HARMSEN, LLC.  
 2822 COLBY AVE., SUITE 300  
 EVERETT, WA, 98201  
 (425) 252-1884

**APPLICANTS**

NORTH STAR VISIONS, LLC.  
 19020 33RD AVE. W #450  
 LYNNWOOD, WA, 98036  
 (425) 778-4111

**CONTACT**

CHER ANDERSON  
 VILLAGE LIFE, INC.  
 19020 33RD AVE. W #450  
 LYNNWOOD, WA, 98036  
 (425) 778-4111

PLN2024-0015

**SURVEYOR**

MATTHEW J. SCHNEIDERS, P.L.S.  
 HARMSEN, LLC.  
 2822 COLBY AVE., SUITE 300  
 EVERETT, WA, 98201  
 (425) 252-1884

**ENGINEER**

DAVID W. HARMSEN, P.E.  
 HARMSEN, LLC.  
 2822 COLBY AVE., SUITE 300  
 EVERETT, WA, 98201  
 (425) 784-7811

REVISIONS:

2/15/2024

**HARMSEN**  
 LAND SURVEYING • CIVIL ENGINEERING • LAND USE PLANNING  
 S/UAS AERIAL MAPPING • WETLAND SERVICES  
 2822 COLBY AVE. SUITE 300  
 EVERETT, WA 98201  
 (425) 252-1884  
 (360) 794-7811

**PRELIMINARY SHORT PLAT FOR DIANNE NELSON**  
 SP S-24-  
 A PORTION OF THE NE 1/4 OF THE NW 1/4 OF SECTION 30, TOWNSHIP 27 NORTH, RANGE 4 EAST, W.M.  
**CITY OF EDMONDS**  
 SNOHOMISH COUNTY, WASHINGTON

**RECEIVED**  
 Feb 22 2024  
 CITY OF EDMONDS DEVELOPMENT SERVICES DEPARTMENT

DRAWN BY: ASL  
 DATE: 01/29/2023  
 PROJECT NO.: 23-313  
 SHEET NO.: 2 OF 3



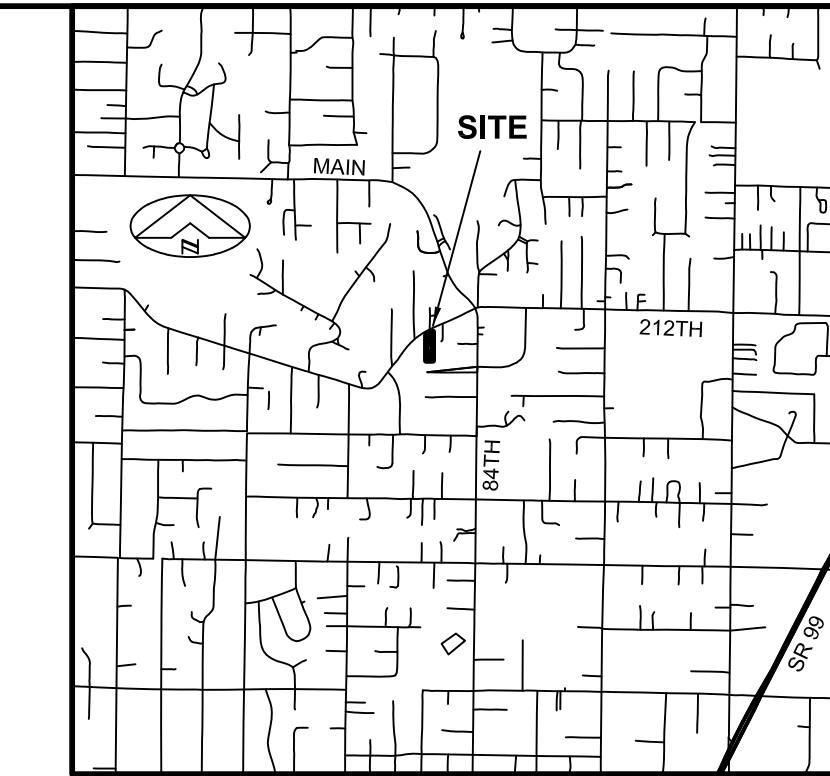
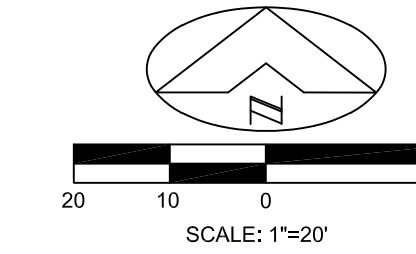
**NELSON SHORT PLAT**

A PORTION OF THE NORTHEAST QUARTER OF THE NORTHWEST QUARTER OF SECTION 30, TOWNSHIP 27 NORTH, RANGE 4 EAST, W.M.

SP S-24-

CITY OF EDMONDS  
SNOHOMISH COUNTY, WASHINGTON

**PRELIMINARY DEVELOPMENT PLAN**

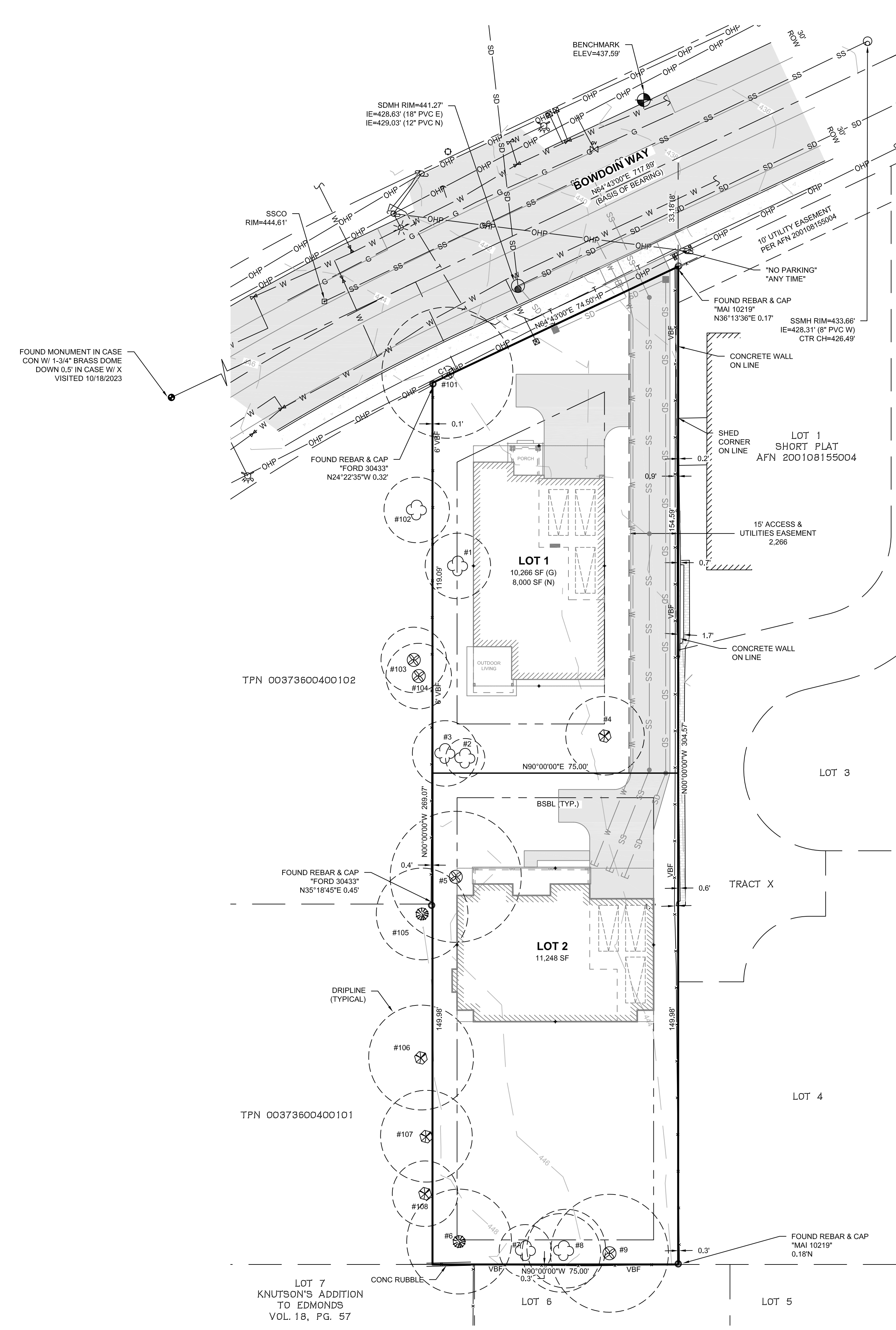


**SITE DATA**

SITE ADDRESS: 8514 BOWDOIN WAY EDMONDS, WA, 98026  
 TAX ACCOUNT NUMBER: 006134-900-001-00  
 EXISTING ZONING: RS-8  
 PROPOSED ZONING: RS-8  
 COMPREHENSIVE PLAN: SINGLE FAMILY-URBAN 1  
 PROPOSED LAND USE: SINGLE-FAMILY RESIDENTIAL  
 SURROUNDING LAND USES: SINGLE-FAMILY RESIDENTIAL  
 GROSS SITE AREA: 21,914 SF (0.49 ACRES)  
 NUMBER OF LOTS PROPOSED: 2  
 UNITS PER ACRE OF LAND: 2 UNITS/0.49 ACRES = 4.1 UNITS PER GROSS ACRE  
 AVERAGE SIZE OF LOTS: 10,757 SF  
 WATER SOURCE/PURVEYOR: PUBLIC/CITY OF EDMONDS  
 SEWAGE DISPOSAL/PURVEYOR: PUBLIC/CITY OF EDMONDS  
 TELEPHONE PURVEYORS: FRONTIER/FINITY  
 POWER/GAS PURVEYOR: PUGET SOUND ENERGY  
 FIRE DISTRICT: SOUTH COUNTY FIRE  
 SCHOOL DISTRICT: EDMONDS SCHOOL DISTRICT NO. 15

CURVE	RADIUS	DELTA ANGLE	ARC LENGTH
C1	543.70'	0°53'36"	8.48'

- LEGEND**
- FOUND MONUMENT AS NOTED
  - FOUND SURVEY MARKER AS NOTED
  - CATCH BASIN T-2
  - WATER VALVE
  - WATER METER
  - FIRE HYDRANT
  - SEWER MANHOLE
  - SEWER CLEAN OUT
  - GAS VALVE
  - POWER METER
  - POWER JUNCTION BOX
  - UTILITY POLE
  - GUY ANCHOR
  - GUY POLE
  - UTILITY POLE MOUNTED LIGHT
  - COMMUNICATIONS RISER
  - MAILBOX
  - SIGN
  - DECIDUOUS TREE (TREE TAG # NOTED)
  - CEDAR TREE (TREE TAG # NOTED)
  - CYPRESS TREE (TREE TAG # NOTED)
  - EVERGREEN TREE (TREE TAG # NOTED)
  - PAVEMENT
  - CONCRETE
  - KEYSTONE WALL
  - VBF VERTICAL BOARD FENCE
  - FENCE LINE
  - SS SEWER LINE
  - SD STORM DRAIN LINE
  - W WATER LINE
  - P UNDERGROUND POWER
  - OHP OVERHEAD UTILITIES
  - T UNDERGROUND COMMUNICATIONS
  - G GAS LINE



FOUND MONUMENT IN CASE CONC MON W/ NAIL VISITED 3-18-14 NOT FOUND THIS SURVEY

FOUND MONUMENT IN CASE CONC W/ 1-3/4" BRASS DISK W/ PUNCH DOWN 0.4" IN CASE S 8°28'26"W 3.67' FROM INTX VISITED 10/18/2023

**LEGAL DESCRIPTION**

PER ALTA COMMITMENT FOR TITLE INSURANCE BY CHICAGO TITLE CO., COMMITMENT NUMBER 500144436, DATED JULY 3, 2023:

LOT 1, WICKSTROMS ADDITION, ACCORDING TO THE PLAT THEREOF RECORDED IN VOLUME 13 OF PLATS, PAGE 106 RECORDS OF SNOHOMISH COUNTY.

SITUATE IN THE COUNTY OF SNOHOMISH, STATE OF WASHINGTON.

**BASIS OF BEARING**

NORTH 63°43'00" EAST BETWEEN FOUND MONUMENTS ALONG THE CENTERLINE OF BOWDOIN WAY PER THE PLAT OF WICKSTROMS ADDITION VOL. 13, PG. 106 AS REFERENCED HEREON.

**DATUM** NAVD 88  
**BENCHMARK**

MAG NAIL & WASHER SET IN NORTH CURB OF BOWDOIN WAY APPROXIMATELY 51.92' NORTH OF THE NORTHEAST PROPERTY CORNER.  
 ELEV=437.59'

**SURVEY REFERENCES**

WICKSTROMS ADDITION VOL. 13, PG. 106  
 RECORD OF SURVEY AFN 202106305002  
 SHORT PLAT AFN 200108155004

**SURVEY NOTES**

EQUIPMENT: 3" OR LESS TOTAL STATION AND GNSS RECEIVER.  
 NETWORK GNSS.

METHOD: FIELD TRAVERSE AND WASHINGTON STATE REFERENCE NETWORK GNSS.

THE CLOSURES OF THE FIELD TRAVERSE CONDUCTED DURING THIS SURVEY MEET OR EXCEED THE MINIMUM CLOSURE STANDARDS STATED IN WAC 332-130-090.

THE TOPOGRAPHIC ELEMENTS AS SHOWN MEET OR EXCEED THOSE REQUIREMENTS STATED IN WAC 332-130-145.

ELEVATION CONTOURS ARE SHOWN AT 2' INTERVALS AND DERIVED FROM DIRECT FIELD OBSERVATIONS. ACCURACY IS PER NATIONAL MAPPING STANDARDS.

THE INFORMATION SHOWN ON THIS MAP REPRESENTS THE RESULTS OF A SURVEY MADE ON THE INDICATED DATE AND CAN ONLY BE CONSIDERED AS THE GENERAL EXISTING CONDITION AT THAT TIME.

**OWNERS**

DIANNE NELSON  
 8514 BOWDOIN WAY  
 EDMONDS, WA, 98026

**PLAN PREPARER**

ANDREW S. LOFSTEDT  
 HARMSEN, LLC.  
 2822 COLBY AVE., SUITE 300  
 EVERETT, WA, 98201  
 (425) 252-1884

**APPLICANTS**

NORTH STAR VISIONS, LLC.  
 19020 33RD AVE. W #450  
 LYNNWOOD, WA, 98036  
 (425) 778-4111

**CONTACT**

CHER ANDERSON  
 VILLAGE LIFE, INC.  
 19020 33RD AVE. W #450  
 LYNNWOOD, WA, 98036  
 (425) 778-4111

**SURVEYOR**

MATTHEW J. SCHNEIDERS, P.L.S.  
 HARMSEN, LLC.  
 2822 COLBY AVE., SUITE 300  
 EVERETT, WA, 98201  
 (425) 252-1884

**ENGINEER**

DAVID W. HARMSEN, P.E.  
 HARMSEN, LLC.  
 2822 COLBY AVE., SUITE 300  
 EVERETT, WA, 98201  
 (425) 784-7811

REVISIONS:

2/15/2024

**HARMSEN**  
 LAND SURVEYING • CIVIL ENGINEERING • LAND USE PLANNING  
 S/UAS AERIAL MAPPING • WETLAND SERVICES  
 2822 COLBY AVE. SUITE 300  
 EVERETT, WA 98201  
 (425) 252-1884  
 (360) 794-7811

**PRELIMINARY SHORT PLAT FOR DIANNE NELSON**  
 SP S-24-  
 A PORTION OF THE NE 1/4 OF THE NW 1/4 OF SECTION 30, TOWNSHIP 27 NORTH, RANGE 4 EAST, W.M.  
 CITY OF EDMONDS  
 SNOHOMISH COUNTY, WASHINGTON

**RECEIVED**  
 Feb 22 2024  
 CITY OF EDMONDS  
 DEVELOPMENT SERVICES DEPARTMENT

DRAWN BY: ASL  
 DATE: 01/29/2023  
 PROJECT NO.: 23-313  
 SHEET NO.: 3 OF 3

**RECEIVED**

PLN2024-0015

Feb 22 2024

CITY OF EDMONDS  
DEVELOPMENT SERVICES  
DEPARTMENT

PRELIMINARY  
**STORMWATER SITE PLAN  
FOR THE**

**NELSON SHORT PLAT  
EDMONDS, WASHINGTON**

JANUARY 18, 2024

Owner  
VILLAGE LIFE, INC.  
CHER ANDERSON  
19020 33RD AVE. W #450  
LYNNWOOD, WA. 98036  
(425) 778-4111

Engineer  
HARMSEN, LLC  
Contact David Harmsen, PE  
2822 Colby Avenue, Suite 300  
Everett WA 98201  
425-252-1884  
davidh@harmssenllc.com



PLN2024-0015 - Stormwater Site Plan for Nelson Short Plat, City of Edmonds, WA - 02/22/2024 - Preliminary

**SNOHOMISH COUNTY**

125 E Main St, Ste 104  
Monroe, Washington 98272  
tel: 360.794.7811 | fax: 360.805.9732

**ISLAND COUNTY**

840 SE 8<sup>th</sup> Avenue, Suite 102  
Oak Harbor, Washington 98277  
tel: 360.675.5973 | fax: 360.675.7255

**SKAGIT COUNTY**

603 South First Street  
Mount Vernon, Washington 98273  
tel: 360.336.9199 | fax: 360.982.2637

[www.Harmssenllc.com](http://www.Harmssenllc.com)

## TABLE OF CONTENTS

Table of Contents	1
Project Overview	2
Methodology	2
MR 1 PREPARATION OF STORMWATER SITEPLANS	3
Existing Conditions/Hydrology	3
Soils	3
Existing Basin	4
Upstream Analysis	4
Downstream Analysis	4
MR 2 SWPPP	5
MR 3: WATER POLLUTION SOURCE CONTROL	6
MR 4: PRESERVATION OF NATURE DRAINAGE	6
Developed Conditions/Hydrology	6
MR 5: ON-SITE STORMWATER MANAGEMENT	6
MR 6: RUNOFF TREATMENT	8
MR 7: FLOW CONTROL	8
MR 8: WETLAND PROTECTION	8
MR 9 OPERATIONS AND MAINTENANCE	8
Figures	
Appendix A – WWHM Data	
Geo-Tech Letter	

## PROJECT OVERVIEW

This Stormwater Site Plan has been prepared for the proposed 2 lot short plat at 8514 Bowdoin Way in the City of Edmonds, Washington (Tax Parcel# 00613400000100), see Figure 1: Vicinity Map. The 0.49-ac site is currently a single family residence with detached garage. The project consists of the demolition of the existing building and subsequently the construction of two new residences.

## METHODOLOGY

The drainage design for the project has been prepared based on the requirements of the Edmonds Stormwater Addendum to the 2019 Department of Ecology Manual as adopted by the City of Edmonds. Note: that requires the use of the WSDOT precipitation numbers. Based on the flow chart and the site parameters, the project is subject to Minimum Requirements 1-9.

The project site parameters are:

- The site has less than 35% existing impervious.
- The project results in greater than 2,000 sf and 5,000 sf of new/replaced impervious.
- The project is not road related.



## **MR 1: PREPARATION OF STORMWATER SITE PLANS**

### DRAINAGE PLAN DESCRIPTION

Roof and access drainage will be collected, detained and discharged to the City storm system in Bowdoin Way. The two structures total 5,480 sf with the combined access being 3,600 sf.

### WATER QUALITY MEASURES

See Minimum Requirement #3.

### FLOW CONTROL

The project does not exceed 0.15 cfs over the pre-development site.

### CONVEYANCE CALCULATIONS

Conveyance calculations would be provided with the permit submittal.

### STORMWATER TREATMENT BMP'S

The area of pavement subject to vehicular traffic is less than 5,000 sf. Treatment is not required.

### PROTECTION OF WETLANDS

There are no wetlands on or near this site.

### OPERATIONS AND MAINTENANCE

An Operations and Maintenance Manual will be provided under the permit documents.

## **EXISTING CONDITIONS/HYDROLOGY SUMMARY**

### DESCRIPTION

The 0.49 ac site is located at 8514 Bowdoin Way. The property is currently a single-family residence with a detached garage. County records indicate the structure was built in 1953. Existing impervious is as follows:

Residence	1,310 sf
Garage	870 sf
Driveway	3,530 sf
Walkway	90 sf
Concrete pad	370 sf
Total Impervious	6,170 sf

Topography descends to the southeast from a high of 449 at the southwest corner to a low of 438 at the northeast corner. The majority of the site is maintained lawn with some landscaping. There are several evergreen trees along the west boundary line.

### SOILS DESCRIPTION

A geotechnical evaluation was prepared by Eartho Solutions NW, LLC They performed a single test pit central to the site which determined glacial till (dense at 3 ft BGS). A PIT was performed at that test pit that yielded no measurable infiltration. As such, the recommendation is that infiltration is not feasible on the site. Groundwater was not encountered at the time of excavation (Aug 14<sup>th</sup>) which would not be unusual given the time of year. It would be expected that perched groundwater would be found on top of the dense till during the wet weather months.

### EXISTING BASIN

The existing basin is the full property.

### UPSTREAM ANALYSIS

The natural slope of the land extends to the west covering most of the adjacent two lots. Lawn and access as well as some roof drains would be expected to flow through the site. See Figure 4 Upstream Basin & Downstream Path in the Figures section of the report. Given that no flow control is proposed (see MR 7) based on the minimal increase in rates; the upstream flow will be allowed to pass through the site as it currently does. The residences will be graded to avoid flow against the building.

### DOWNSTREAM ANALYSIS

According to the Edmonds GIS storm system, the site would connect to an 18" storm system in Bowdoin Way that changes to an 8" storm system that flows to the northeast. At the roundabout a flow splitter is located. The structure indicates that flows to the north are normal with overflows to the southeast. Following the normal flow north, a 13" pipe run leads through the intersection to 84<sup>th</sup> Ave W as it leaves the roundabout to the north. There the flow enters a vault (likely for the roundabout) before continuing north up first 84<sup>th</sup> and then Woodlake Drive ultimately flowing through the cul-de-sac and then backyards to reach Pine Ridge Park and the lake/pond there. The junction of several flow paths, the lake discharges to the west in an open channel before entering a 24" pipe that crosses Main St to the south and continues south southwest along Pioneer Way. Flow continues to the southwest in an 18" pipe ultimately reaching Shell Creek at Shell Valley Road where an open channel (with several 24" culverts) directs flow to the west northwest continuing through Yost Park and again crossing Main Street. Shell Creek continues in a generally north direction, ultimately discharging to Puget Sound. See Figure 4 Upstream Basin & Downstream Path

The only 303d listing is a Cat 5 of Puget Sound (north-central) for Bacterial - Enterococci.

There is no indication that this storm system would be negatively impacted by the proposed development.



## **MR 2: CONSTRUCTION STORMWATER POLLUTION PREVENTION (SWPP)**

The site results in less than 1-acre of disturbed area and will not require a DOE Construction Stormwater Permit. Suitable SWPPP will be provided as part of the construction documents. Anticipated BMPs would be:

BMP C103 High Visibility Fencing

BMP C105 Stabilized Construction Entrance

BMP C120 Temporary and Permanent Seeding

BMP C220 Storm Inlet Protection

BMP C233 Silt Fence

## **MR 3: WATER POLLUTION SOURCE CONTROL**

### **PERMANENT WATER POLLUTION SOURCE CONTROLS**

The following source controls apply:

S411 – BMPs for landscaping and lawn/vegetation management;

S438 – BMPs for construction demolition;

S440 – BMPs for pet waste;

S441 – BMPs for fertilizer application;

S452 – BMPs for building, repair, remodeling, painting, and construction.

## **MR 4: PRESERVATION OF NATURAL DRAINAGE**

There are no natural drainage systems in the local area. The discharge from the site will preserve the current flow paths.

There is no indication of storm water issues in the local area. The descent to the northeast is significant and no back up of off-site water is expected. The completed site will not have significant surface flows that would be subject to erosion and the downstream is completely contained until Shell Creek is reached, approximately 3,150 feet from the site.

## **DEVELOPED CONDITIONS/HYDROLOGY SUMMARY**

### **DESCRIPTION**

The project is a two-lot short plat. Two new residences with a shared driveway will be constructed. The two structures total 5,480 sf with the combined access being 3,600 sf.

## **MR 5: ON-SITE STORMWATER MANAGEMENT**

The site does not discharge into Flow Control Exempt Waters, flows to an MS4, and triggers Minimum Requirements 1-9. The site developer has chosen not to meet Low Impact Development Performance Standard and must address the BMPs of List 2 in order.

NOTE: the geotechnical engineer performed an on-site PIT for infiltration and the result was no infiltration rate.

Lawn and Landscape:

All new and disturbed pervious areas will have BMP T5.13 applied to them.

## Roof

### Full Dispersion BMP T5.30:

This BMP is infeasible as the 65 to 10 ratio of forested or native vegetation area to impervious area cannot be achieved. There is no native vegetation.

### Downspout Infiltration BMP T5.10A:

This BMP is infeasible as the soils are not outwash or loam soils.

### Bioretention, Swales, Planter Box BMP T7.30:

This BMP is infeasible as field testing indicates no infiltration rate.

### Downspout Dispersion System BMP T5.10B:

This BMP is infeasible because there is not adequate vegetated flow path.

### Detention Vaults and Pipes/Tanks

The site does not require flow control due to less than 0.15 cfs increase and the downstream analysis did not indicate any issues.

### Perforated Stub-out Connections BMP T5.10C:

This is infeasible as the dense till is at 3 feet with expected perched groundwater that would reduce permeable soil under the system to less than 1 foot.

The roof runoff will be connected directly into the site conveyance system.

## Other Hard surfaces

### Full Dispersion BMP T5.30:

This BMP is infeasible as the 65 to 10 ratio of forested or native vegetation area to impervious area cannot be achieved. There is no native vegetation.

### Permeable Pavement Surfaces BMP T5.15:

This BMP is infeasible as the soils were field tested and found to be without measurable infiltration rate.

### Bioretention, Swales, Planter Box BMP T7.30:

This BMP is infeasible as field testing indicates no infiltration rate.

### Concentrated Flow Dispersion System BMP T5.12:

This BMP is infeasible because there is not adequate vegetated flow path.

### Detention Vaults and Pipes/Tanks

The site does not require flow control due to less than 0.15 cfs increase and the downstream analysis did not indicate any issues.

Based on available soils testing data and the site characteristics, BMP T5.13 post-Construction Soil Quality and Depth will be used.

## **MR 6: RUNOFF TREATMENT**

The project has less than 5,000 sf of pollution generating hard surface and less than 0.75 acres of pollution generating pervious surface. Treatment is not required.

## **MR 7: FLOW CONTROL**

The basin area is the total site area of 0.49 acres. The initial calculation is to check post-development flows against pre-development flows. The single family residence is listed as a 1953 construction prior to the 1977 adoption of drainage codes in Edmonds.

The pre-developed site has:

Roads:	0.08 ac
Roofs:	0.05 ac
Walks:	0.01 ac
Lawn:	0.35 ac

Yielding a 100 year flow of 0.15 cfs

The post-developed site has:

Roads:	0.08 ac
Roofs:	0.12 ac
Walks:	0.01 ac
Lawn:	0.28 ac

Yielding a 100 year flow of 0.18 cfs

A 0.03 cfs increase is below the threshold requiring detention. See WWHM data attached in the appendix.

Flows will be connected to the City storm system.

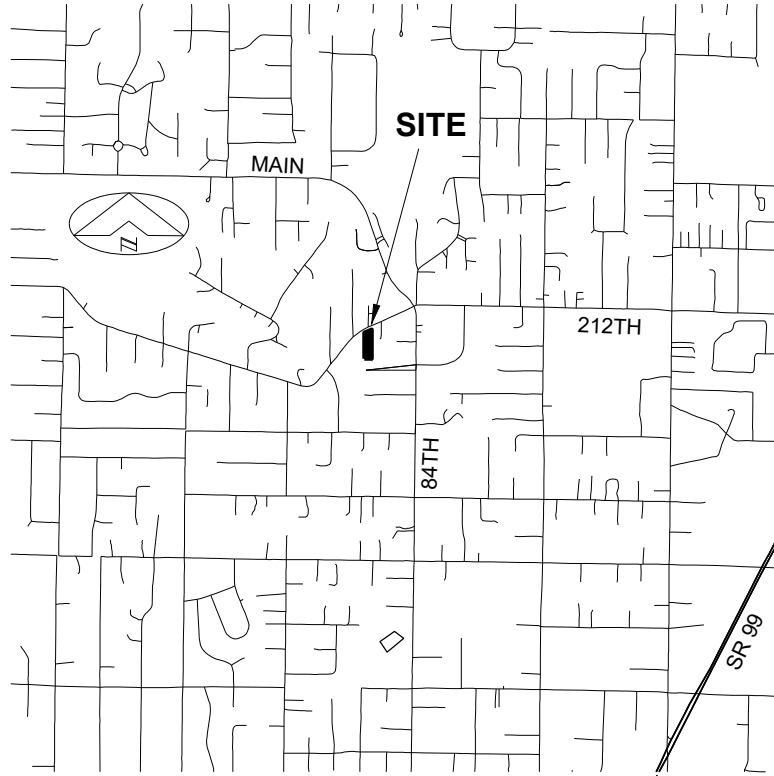
## **MR 8: WETLANDS PROTECTION**

There are no wetlands on the site.

## **MR 9: OPERATION AND MAINTENANCE**

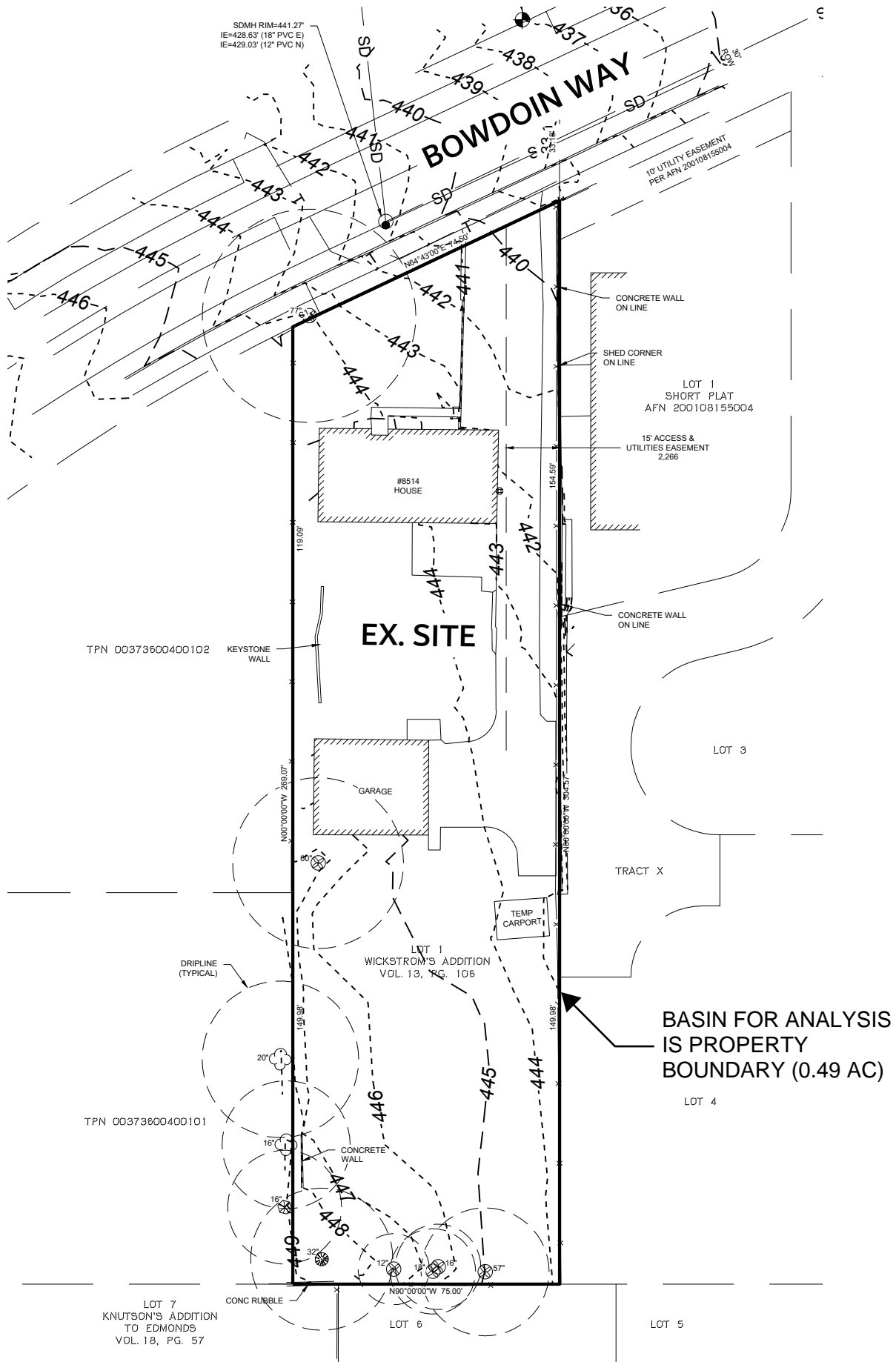
An Operations and Maintenance Manual would be provided with the permit documents.

# FIGURES



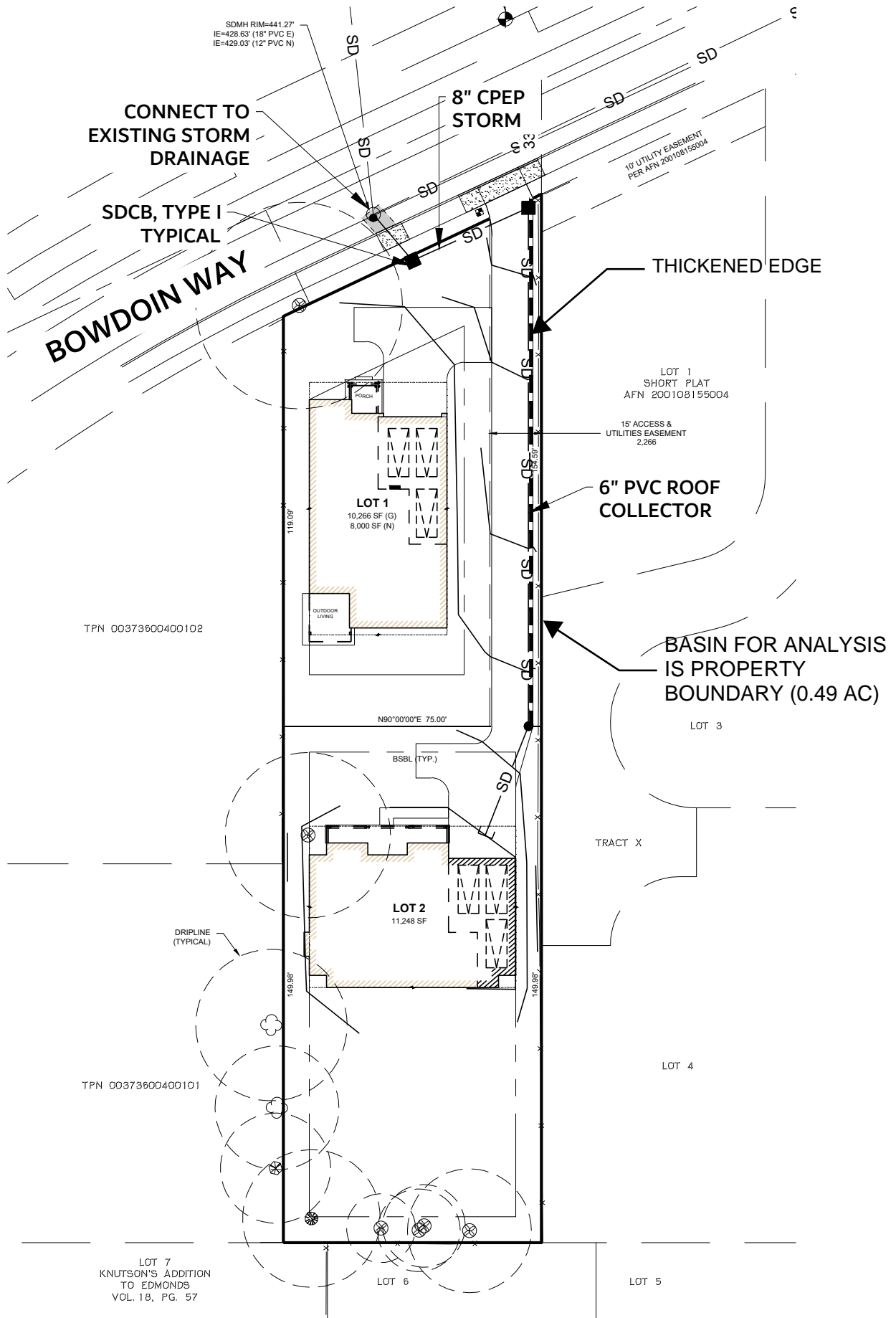
**FIGURE 1 - VICINITY MAP**

SCALE: 1" = 2000'



**FIGURE 2 - EXISTING CONDITIONS**

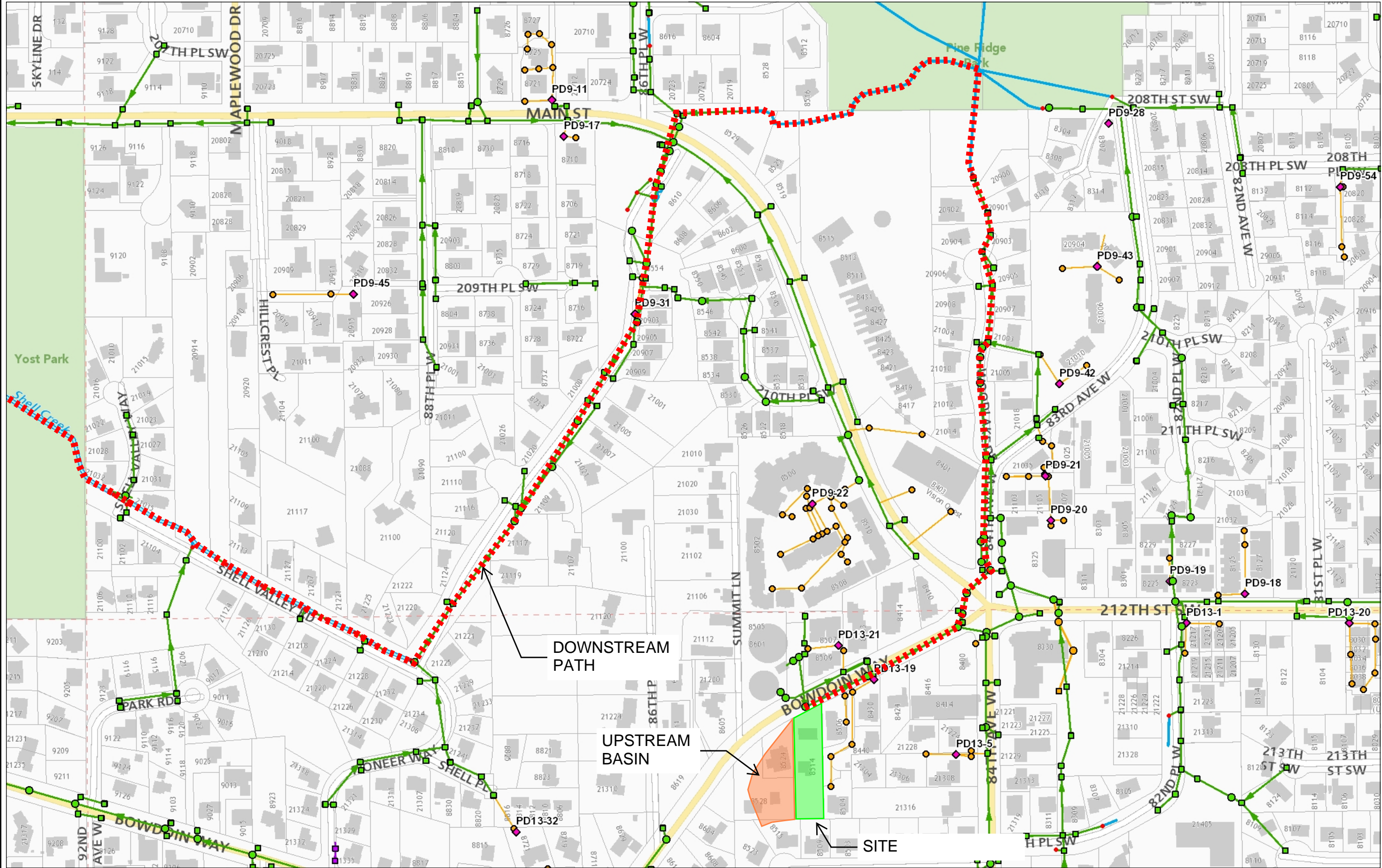
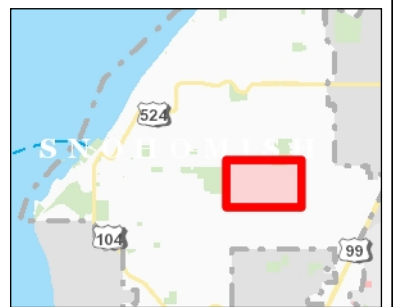
SCALE: 1" = 40'



**FIGURE 3 - DEVELOPED CONDITIONS**

SCALE: 1" = 40'





### Legend

- Storm Catch Basins**
  - Edmonds (Green square)
  - Private (Orange square)
  - Infiltration (Purple square)
- Storm Manholes**
  - Edmonds (Green circle)
  - Private (Orange circle)
  - Infiltration (Purple circle)
- Detention Facilities** (Purple diamond)
- Culvert**
  - <all other values> (Red dot)
  - Yes (Purple dot)
- Facility Feature** (Orange circle)
- Creeks** (Blue line)
- Storm Line**
  - <all other values> (Green line)
  - No, BNSF; No, COUNTY; No, LYNI MOUNTLAKE TERRACE; No, POB SHORELINE; No, STATE; No, WO (Yellow line)
  - Yes, EDMONDS; Yes, PRIVATE; 1 (Purple line)
- Facility Lines** (Yellow line)
- Storm Ditch** (Blue line)
- Sections Boundary** (Red dashed line)
- Sections** (Grey dashed line)
- Edmonds Boundary** (Grey dashed line)
- ArcSDE.GIS.PROPERTY\_BUILDING** (Grey solid line)
- ArcSDE.GIS.STREET\_CENTERLINE:**
  - <all other values> (Red dashed line)
  - Interstate (Orange solid line)
  - Principal Arterial (Yellow solid line)
  - Minor Arterial; Collector (Light yellow solid line)
  - Local Street; On Ramp (Grey solid line)
- State Highways**
  - <all other values> (Green line)
  - 0 (Blue dashed line)
  - 1 (Yellow dashed line)
  - 2 (Light yellow dashed line)
- County Boundary** (Grey dashed line)

1:3,031

Notes

505.2 0 252.60 505.2 Feet

WGS\_1984\_Web\_Mercator\_Auxiliary\_Sphere  
© City of Edmonds

## FIGURE 4: UPSTREAM BASIN & DOWNSTREAM PATH

This map is a user generated static output from an Internet mapping site and is for reference only. Data layers that appear on this map may not be accurate. THIS MAP IS NOT TO BE USED FOR DESIGN OR CONSTRUCTION

# WWHM DATA

WWHM2012  
PROJECT REPORT

---

**Project Name:** Nelson SP  
**Site Name:**  
**Site Address:**  
**City :**  
**Report Date:** 1/18/2024  
**MGS Regoin :** Puget East  
**Data Start :** 1901/10/1  
**Data End :** 2058/09/30  
**DOT Data Number:** 03  
**Version Date:** 2021/08/18  
**Version :** 4.2.18

---

**Low Flow Threshold for POC 1 :** 50 Percent of the 2 Year

---

**High Flow Threshold for POC 1:** 50 year

---

**PREDEVELOPED LAND USE**

**Name :** Basin 1  
**Bypass:** No

**GroundWater:** No

<u>Pervious Land Use</u>	<u>acre</u>
C, Lawn, Flat	.35
<b>Pervious Total</b>	<b>0.35</b>
<u>Impervious Land Use</u>	<u>acre</u>
ROADS FLAT	0.08
ROOF TOPS FLAT	0.05
SIDEWALKS FLAT	0.01
<b>Impervious Total</b>	<b>0.14</b>
<b>Basin Total</b>	<b>0.49</b>

---

**Element Flows To:**

<b>Surface</b>	<b>Interflow</b>	<b>Groundwater</b>
----------------	------------------	--------------------

---

**MITIGATED LAND USE**

**Name :** Basin 1  
**Bypass:** No

GroundWater: No

<u>Pervious Land Use</u>	<u>acre</u>
C, Lawn, Flat	.28
Pervious Total	0.28
<u>Impervious Land Use</u>	<u>acre</u>
ROADS FLAT	0.08
ROOF TOPS FLAT	0.12
SIDEWALKS FLAT	0.01
Impervious Total	0.21
Basin Total	0.49

---

Element Flows To:		
Surface	Interflow	Groundwater

---

---

ANALYSIS RESULTS

Stream Protection Duration

---

Predeveloped Landuse Totals for POC #1  
Total Pervious Area:0.35  
Total Impervious Area:0.14

---

Mitigated Landuse Totals for POC #1  
Total Pervious Area:0.28  
Total Impervious Area:0.21

---

Flow Frequency Return Periods for Predeveloped. POC #1

<u>Return Period</u>	<u>Flow(cfs)</u>
2 year	0.046935
5 year	0.068124
10 year	0.084824
25 year	0.109245
50 year	0.130036
100 year	0.153219

Flow Frequency Return Periods for Mitigated. POC #1

<u>Return Period</u>	<u>Flow(cfs)</u>
2 year	0.0617
5 year	0.086098

<b>10 year</b>	0.104748
<b>25 year</b>	0.131346
<b>50 year</b>	0.153491
<b>100 year</b>	0.177747

---

**Stream Protection Duration**

**Annual Peaks for Predeveloped and Mitigated. POC #1**

<b>Year</b>	<b>Predeveloped</b>	<b>Mitigated</b>
1902	0.039	0.058
1903	0.049	0.069
1904	0.081	0.099
1905	0.030	0.040
1906	0.032	0.043
1907	0.057	0.070
1908	0.042	0.055
1909	0.046	0.062
1910	0.061	0.074
1911	0.043	0.057
1912	0.136	0.150
1913	0.034	0.042
1914	0.144	0.178
1915	0.030	0.041
1916	0.041	0.058
1917	0.029	0.039
1918	0.038	0.054
1919	0.027	0.036
1920	0.043	0.055
1921	0.033	0.042
1922	0.047	0.059
1923	0.049	0.061
1924	0.044	0.065
1925	0.027	0.038
1926	0.045	0.066
1927	0.038	0.052
1928	0.040	0.052
1929	0.069	0.088
1930	0.064	0.089
1931	0.034	0.044
1932	0.041	0.053
1933	0.038	0.049
1934	0.077	0.091
1935	0.032	0.042
1936	0.040	0.052
1937	0.064	0.078
1938	0.037	0.048
1939	0.040	0.057
1940	0.065	0.084
1941	0.044	0.064
1942	0.059	0.074
1943	0.060	0.078
1944	0.101	0.125
1945	0.055	0.074
1946	0.043	0.055
1947	0.032	0.045
1948	0.055	0.068
1949	0.068	0.093

1950	0.031	0.039
1951	0.037	0.056
1952	0.124	0.141
1953	0.113	0.131
1954	0.044	0.057
1955	0.036	0.047
1956	0.025	0.035
1957	0.039	0.053
1958	0.072	0.084
1959	0.061	0.074
1960	0.037	0.050
1961	0.139	0.170
1962	0.043	0.056
1963	0.025	0.035
1964	0.112	0.132
1965	0.056	0.071
1966	0.035	0.048
1967	0.050	0.061
1968	0.038	0.050
1969	0.045	0.058
1970	0.058	0.072
1971	0.064	0.078
1972	0.205	0.241
1973	0.066	0.096
1974	0.064	0.084
1975	0.102	0.119
1976	0.073	0.090
1977	0.027	0.036
1978	0.068	0.081
1979	0.050	0.065
1980	0.052	0.066
1981	0.051	0.068
1982	0.038	0.051
1983	0.060	0.076
1984	0.054	0.070
1985	0.059	0.073
1986	0.034	0.044
1987	0.057	0.068
1988	0.036	0.047
1989	0.031	0.042
1990	0.039	0.049
1991	0.057	0.075
1992	0.065	0.082
1993	0.054	0.078
1994	0.052	0.064
1995	0.026	0.035
1996	0.052	0.064
1997	0.037	0.049
1998	0.054	0.068
1999	0.041	0.060
2000	0.057	0.073
2001	0.037	0.054
2002	0.093	0.110
2003	0.040	0.051
2004	0.058	0.078
2005	0.091	0.119
2006	0.035	0.048



2007	0.058	0.075
2008	0.039	0.053
2009	0.039	0.053
2010	0.050	0.066
2011	0.027	0.039
2012	0.057	0.073
2013	0.040	0.051
2014	0.031	0.046
2015	0.115	0.129
2016	0.030	0.042
2017	0.073	0.098
2018	0.076	0.087
2019	0.097	0.112
2020	0.067	0.083
2021	0.061	0.076
2022	0.069	0.090
2023	0.058	0.085
2024	0.163	0.181
2025	0.030	0.045
2026	0.049	0.059
2027	0.051	0.067
2028	0.019	0.028
2029	0.043	0.055
2030	0.064	0.080
2031	0.022	0.032
2032	0.030	0.041
2033	0.027	0.040
2034	0.033	0.043
2035	0.064	0.076
2036	0.043	0.053
2037	0.038	0.056
2038	0.060	0.073
2039	0.062	0.091
2040	0.040	0.053
2041	0.047	0.062
2042	0.070	0.084
2043	0.056	0.072
2044	0.048	0.060
2045	0.043	0.055
2046	0.040	0.051
2047	0.039	0.059
2048	0.036	0.052
2049	0.056	0.079
2050	0.041	0.053
2051	0.082	0.099
2052	0.035	0.049
2053	0.035	0.051
2054	0.097	0.112
2055	0.039	0.052
2056	0.044	0.063
2057	0.031	0.042
2058	0.045	0.067

---

**Stream Protection Duration**

**Ranked Annual Peaks for Predeveloped and Mitigated. POC #1**

**Rank            Predeveloped            Mitigated**

1	0.2050	0.2412
2	0.1632	0.1815
3	0.1442	0.1775
4	0.1388	0.1701
5	0.1357	0.1505
6	0.1240	0.1411
7	0.1149	0.1321
8	0.1133	0.1311
9	0.1120	0.1289
10	0.1019	0.1251
11	0.1013	0.1192
12	0.0975	0.1186
13	0.0973	0.1122
14	0.0931	0.1121
15	0.0909	0.1103
16	0.0817	0.0994
17	0.0808	0.0989
18	0.0769	0.0981
19	0.0761	0.0956
20	0.0733	0.0934
21	0.0729	0.0907
22	0.0723	0.0906
23	0.0701	0.0903
24	0.0690	0.0900
25	0.0687	0.0890
26	0.0677	0.0885
27	0.0677	0.0869
28	0.0674	0.0850
29	0.0657	0.0844
30	0.0653	0.0841
31	0.0645	0.0841
32	0.0642	0.0838
33	0.0641	0.0830
34	0.0639	0.0819
35	0.0639	0.0814
36	0.0638	0.0797
37	0.0637	0.0786
38	0.0621	0.0784
39	0.0610	0.0783
40	0.0605	0.0782
41	0.0605	0.0781
42	0.0603	0.0776
43	0.0602	0.0763
44	0.0596	0.0763
45	0.0594	0.0755
46	0.0589	0.0754
47	0.0585	0.0752
48	0.0584	0.0741
49	0.0584	0.0739
50	0.0578	0.0737
51	0.0572	0.0737
52	0.0572	0.0730
53	0.0568	0.0728
54	0.0566	0.0728
55	0.0565	0.0727
56	0.0563	0.0724
57	0.0560	0.0719

58	0.0560	0.0707
59	0.0552	0.0696
60	0.0549	0.0695
61	0.0539	0.0692
62	0.0536	0.0685
63	0.0536	0.0684
64	0.0522	0.0679
65	0.0518	0.0676
66	0.0517	0.0668
67	0.0513	0.0667
68	0.0508	0.0664
69	0.0500	0.0663
70	0.0497	0.0656
71	0.0496	0.0649
72	0.0486	0.0647
73	0.0486	0.0645
74	0.0485	0.0645
75	0.0480	0.0640
76	0.0469	0.0632
77	0.0467	0.0624
78	0.0460	0.0617
79	0.0448	0.0614
80	0.0447	0.0614
81	0.0446	0.0601
82	0.0445	0.0599
83	0.0444	0.0594
84	0.0442	0.0588
85	0.0437	0.0587
86	0.0434	0.0582
87	0.0432	0.0578
88	0.0428	0.0576
89	0.0428	0.0575
90	0.0426	0.0569
91	0.0426	0.0568
92	0.0425	0.0564
93	0.0423	0.0557
94	0.0413	0.0555
95	0.0409	0.0554
96	0.0407	0.0552
97	0.0406	0.0551
98	0.0403	0.0546
99	0.0403	0.0546
100	0.0400	0.0545
101	0.0399	0.0543
102	0.0399	0.0534
103	0.0398	0.0531
104	0.0397	0.0529
105	0.0394	0.0528
106	0.0393	0.0528
107	0.0391	0.0527
108	0.0389	0.0527
109	0.0386	0.0525
110	0.0386	0.0524
111	0.0385	0.0518
112	0.0383	0.0516
113	0.0382	0.0515
114	0.0381	0.0511



115	0.0378	0.0508
116	0.0378	0.0506
117	0.0376	0.0506
118	0.0371	0.0506
119	0.0370	0.0501
120	0.0370	0.0496
121	0.0365	0.0494
122	0.0365	0.0493
123	0.0362	0.0491
124	0.0358	0.0487
125	0.0357	0.0480
126	0.0355	0.0478
127	0.0352	0.0477
128	0.0348	0.0472
129	0.0347	0.0467
130	0.0343	0.0462
131	0.0343	0.0447
132	0.0338	0.0446
133	0.0334	0.0445
134	0.0328	0.0441
135	0.0324	0.0435
136	0.0318	0.0433
137	0.0316	0.0423
138	0.0314	0.0423
139	0.0314	0.0422
140	0.0309	0.0421
141	0.0307	0.0420
142	0.0304	0.0416
143	0.0303	0.0411
144	0.0302	0.0410
145	0.0298	0.0402
146	0.0297	0.0399
147	0.0286	0.0394
148	0.0272	0.0393
149	0.0268	0.0392
150	0.0268	0.0376
151	0.0266	0.0362
152	0.0266	0.0357
153	0.0263	0.0354
154	0.0255	0.0353
155	0.0246	0.0348
156	0.0221	0.0317
157	0.0188	0.0279

---

**Stream Protection Duration**

**POC #1**

**The Facility FAILED**

**Facility FAILED duration standard for 1+ flows.**

<b>Flow(cfs)</b>	<b>Predev</b>	<b>Mit</b>	<b>Percentage</b>	<b>Pass/Fail</b>
0.0235	2203	5259	238	Fail
0.0245	1881	4628	246	Fail
0.0256	1627	4079	250	Fail
0.0267	1413	3607	255	Fail
0.0278	1236	3227	261	Fail

0.0288	1062	2886	271	Fail
0.0299	944	2552	270	Fail
0.0310	823	2241	272	Fail
0.0321	739	1982	268	Fail
0.0332	660	1768	267	Fail
0.0342	607	1581	260	Fail
0.0353	544	1404	258	Fail
0.0364	495	1285	259	Fail
0.0375	451	1149	254	Fail
0.0385	409	1016	248	Fail
0.0396	377	909	241	Fail
0.0407	342	827	241	Fail
0.0418	317	751	236	Fail
0.0428	293	689	235	Fail
0.0439	262	641	244	Fail
0.0450	234	584	249	Fail
0.0461	221	532	240	Fail
0.0471	202	492	243	Fail
0.0482	192	460	239	Fail
0.0493	176	432	245	Fail
0.0504	165	410	248	Fail
0.0515	151	380	251	Fail
0.0525	140	349	249	Fail
0.0536	131	326	248	Fail
0.0547	125	302	241	Fail
0.0558	115	282	245	Fail
0.0568	102	259	253	Fail
0.0579	94	240	255	Fail
0.0590	86	222	258	Fail
0.0601	82	211	257	Fail
0.0611	73	198	271	Fail
0.0622	69	189	273	Fail
0.0633	66	177	268	Fail
0.0644	56	167	298	Fail
0.0654	53	155	292	Fail
0.0665	49	140	285	Fail
0.0676	45	134	297	Fail
0.0687	42	123	292	Fail
0.0698	39	112	287	Fail
0.0708	36	106	294	Fail
0.0719	36	105	291	Fail
0.0730	32	98	306	Fail
0.0741	28	91	325	Fail
0.0751	28	85	303	Fail
0.0762	27	77	285	Fail
0.0773	26	70	269	Fail
0.0784	26	64	246	Fail
0.0794	26	60	230	Fail
0.0805	26	57	219	Fail
0.0816	25	54	216	Fail
0.0827	23	50	217	Fail
0.0837	23	49	213	Fail
0.0848	23	45	195	Fail
0.0859	22	44	200	Fail
0.0870	22	40	181	Fail
0.0881	22	39	177	Fail
0.0891	21	36	171	Fail

0.0902	20	34	170	Fail
0.0913	19	29	152	Fail
0.0924	19	29	152	Fail
0.0934	18	28	155	Fail
0.0945	17	28	164	Fail
0.0956	17	27	158	Fail
0.0967	17	26	152	Fail
0.0977	14	26	185	Fail
0.0988	14	25	178	Fail
0.0999	14	23	164	Fail
0.1010	14	22	157	Fail
0.1020	12	22	183	Fail
0.1031	12	22	183	Fail
0.1042	12	21	175	Fail
0.1053	12	21	175	Fail
0.1064	12	21	175	Fail
0.1074	12	21	175	Fail
0.1085	12	20	166	Fail
0.1096	12	20	166	Fail
0.1107	12	18	150	Fail
0.1117	12	18	150	Fail
0.1128	11	16	145	Fail
0.1139	10	16	160	Fail
0.1150	10	16	160	Fail
0.1160	9	16	177	Fail
0.1171	9	15	166	Fail
0.1182	9	15	166	Fail
0.1193	9	13	144	Fail
0.1203	8	13	162	Fail
0.1214	8	13	162	Fail
0.1225	8	13	162	Fail
0.1236	8	13	162	Fail
0.1247	7	13	185	Fail
0.1257	7	12	171	Fail
0.1268	7	12	171	Fail
0.1279	7	12	171	Fail
0.1290	6	11	183	Fail
0.1300	6	11	183	Fail

---

The development has an increase in flow durations from 1/2 Predeveloped 2 year flow to the 2 year flow or more than a 10% increase from the 2 year to the 50 year flow.

The development has an increase in flow durations for more than 50% of the flows for the range of the duration analysis.

---

**Water Quality BMP Flow and Volume for POC #1**

On-line facility volume: 0 acre-feet

On-line facility target flow: 0 cfs.

Adjusted for 15 min: 0 cfs.

Off-line facility target flow: 0 cfs.

Adjusted for 15 min: 0 cfs.

---

LID Technique Percent	Water Quality	Used for Percent Treatment? Water Quality	Total Volume Comment Needs Treatment (ac-ft)	Volume Through Facility (ac-ft)	Infiltration Volume (ac-ft.)	Cumulative Volume Infiltration Credit
0.00	0%	No Treat.	0.00	0.00	0.00	0.00
Compliance with LID Standard 8						
Duration Analysis Result = Failed						

---

**PerlnD and ImplnD Changes**

No changes have been made.

---

This program and accompanying documentation are provided 'as-is' without warranty of any kind. The entire risk regarding the performance and results of this program is assumed by End User. Clear Creek Solutions Inc. and the governmental licensee or sublicensees disclaim all warranties, either expressed or implied, including but not limited to implied warranties of program and accompanying documentation. In no event shall Clear Creek Solutions Inc. be liable for any damages whatsoever (including without limitation to damages for loss of business profits, loss of business information, business interruption, and the like) arising out of the use of, or inability to use this program even if Clear Creek Solutions Inc. or their authorized representatives have been advised of the possibility of such damages. Software Copyright © by : Clear Creek Solutions, Inc. 2005-2024; All Rights Reserved.





November 2, 2023  
ES-9407.01

## Earth Solutions NW LLC

Geotechnical Engineering, Construction  
Observation/Testing and Environmental Services

North Star Visions, LLC  
19020 – 33<sup>rd</sup> Avenue West, Suite 450  
Lynnwood, Washington 98036

Attention: Lucas Kragt, P.E.

**Subject: Geotechnical Evaluation  
Proposed Single-Family Residences  
8514 Bowdoin Way  
Edmonds, Washington**

Dear Lucas:

As requested, Earth Solutions NW, LLC (ESNW) has prepared this geotechnical evaluation for the proposed project. We performed our work in general accordance with the scope of services outlined in the proposal dated September 5, 2023, which was authorized on September 6, 2023. A summary of the subsurface exploration, laboratory analyses, and recommendations with respect to the proposed project are provided in this letter report.

### **Project & Site Description**

The subject site is located at 8514 Bowdoin Way in Edmonds, Washington. The site consists of one tax parcel (Snohomish County Parcel No. 0061340000-0100) and totals about 0.49 acres of land area. The approximate site location is depicted on Plate 1 (Vicinity Map).

The site is currently developed with a single-family residence, detached garage, and associated improvements. Site topography gently descends to the east-northeast for less than about 10 feet of topographic relief within the property boundaries.

We understand the property will be redeveloped with two new single-family residential lots and associated improvements. Stormwater will likely be directed to a detention pipe. At the time this letter was prepared, however, neither site plans nor preliminary layout information were available for review. We anticipate that the new single-family residential structures will be two to three stories in height and will consist of relatively lightly loaded wood framing supported on conventional foundations. Based on our experience with similar developments, we estimate wall loads on the order of 1 to 2 kips per linear foot, column loads of up to about 20 kips, and slab-on-grade loading of 150 pounds per square foot (psf).

## **Subsurface Conditions**

An ESNW representative observed, logged, and sampled one test pit on August 14, 2023. The test pit was excavated at an accessible location within the property boundaries using a mini trackhoe and operator retained by ESNW; site access limitations restricted the ability to complete additional test pits. The test pit was completed to characterize and classify the site soil and groundwater conditions within areas proposed for new development, and to complete one small-scale Pilot Infiltration Test. The maximum exploration depth was approximately eight feet below the existing ground surface (bgs).

The approximate location of the test pit is depicted on Plate 2 (Test Pit Location Plan). Please refer to the attached test pit log for a more detailed description of subsurface conditions. Representative soil samples collected at the exploration location were analyzed in general accordance with Unified Soil Classification System (USCS) and United States Department of Agriculture (USDA) methods and procedures.

### **Topsoil**

Topsoil was encountered within the upper four inches of existing grades at the test pit location. Deeper pockets of topsoil may be present in localized areas across the site. The topsoil was characterized by its dark brown color, presence of fine organic material, and small root intrusions.

### **Fill**

Fill was not observed at the test pit location.

### **Native Soil**

Underlying the topsoil, native soil consisting of silty sand with gravel was observed, consistent with the typical make-up of glacial till deposits. Nearest the surface, the native soil was generally in a relatively weathered (brown) and medium dense to dense condition, transitioning into a very dense, weakly cemented, and unweathered (gray) condition beginning at roughly three feet bgs. Undisturbed very dense native soil deposits were observed extending to the maximum exploration depth of about eight feet bgs.

Based on laboratory analyses of representative soil samples, the native glacial till deposits have a fines content between about 32 and 39 percent and were primarily observed in a moist condition at the time of exploration.

### **Geologic Setting**

The local geologic map indicates the site is underlain by Vashon glacial till (Qvt) deposits. As reported on the geologic map, Vashon glacial till consists primarily of a non-sorted mixture of silt, sand, and sub-rounded to well-rounded gravels, commonly referred to as "hardpan." The till was deposited directly from the glacier as it advanced over bedrock and older Quaternary sediment.

The Web Soil Survey identifies Alderwood-urban land complex as the primary soil unit underlying the subject site. Alderwood series soils formed over glacial deposits beneath conifer trees. Urban land is described as areas that are covered by streets, buildings, parking lots, and other structures that obscure or alter the soils so that identification is not possible; classification as urban land also suggests that man-made modifications to the natural landscape have occurred in the past, including grade cuts or fills. Alderwood-urban land complex soils are characterized by the USDA with slow stormwater runoff and slight hazard of water erosion.

In our opinion, based on our subsurface observations, the native soils are generally consistent with glacial till deposits and Alderwood series soil.

### **Groundwater**

Groundwater seepage was not observed during the subsurface exploration.

It should be noted that zones of perched groundwater seepage are common within glacial deposits, and groundwater seeps should be expected within site excavations at depth. Groundwater seepage rates and elevations may fluctuate depending on many factors, including precipitation duration and intensity, the time of year, and soil conditions. In general, groundwater flow rates are higher during the winter, spring, and early summer months.

### **Geologically Hazardous Areas Review**

ESNW reviewed ECC Chapter 23.80 to evaluate the presence of geologically hazardous areas at the subject site. We also reviewed the City of Edmonds (City) online GIS resource, which depicts suspected geologically hazardous areas within city limits. Geologically hazardous areas in the city include areas susceptible to erosion, land sliding, earthquake, or other geological events.

Based on our review, the site contains small, isolated erosion hazard areas per the GIS resource. Additionally, the site is located within the greater Southern Whidbey Island Fault zone, with suspected, associated fault strands identified by regional mapping resources within about a half-mile both north and south of the subject site. Further discussion regarding on-site erosion and seismic hazards is provided below. Potential landslide hazard areas were not identified at the property.

### **Erosion Hazard Areas**

Erosion hazard areas are defined as those areas identified by the USDA's Natural Resources Conservation Service as having a "moderate to severe," "severe," or "very severe" rill and inter-rill erosion hazard. Erosion hazard areas are also those areas impacted by shoreland and/or stream bank erosion. Erosion hazard typically increases with slope gradient.

As noted in the *Geologic Setting* section of this letter, the native soils are identified as Alderwood-urban land complex soils, which are further characterized by the USDA with slight hazard of water erosion.

Based on our site observations and readily available topographic mapping, in our opinion, the mapping of on-site erosion hazard areas by the city's GIS resource is erroneous. The site topography is relatively level and the erosion potential of native soils in a typical construction setting would be characterized as low.

### **Seismic Hazard Areas**

Seismic hazard areas in the city are areas subject to severe risk of damage as a result of earthquake-induced ground shaking, slope failure, settlement, soil liquefaction, lateral spreading, or surface faulting.

Liquefaction is a phenomenon that can occur within a soil profile as a result of an intense ground shaking or loading condition. Most commonly, liquefaction is caused by ground shaking during an earthquake. Fine sand or silt soil profiles that are loose, cohesionless, and present below the groundwater table are most susceptible to liquefaction. During the ground shaking, the soil contracts, and porewater pressure increases. The increased porewater pressure occurs quickly and without sufficient time to dissipate, resulting in water flowing upward to the ground surface and a liquefied soil condition. Soil in a liquefied condition possesses very little shear strength in comparison to the drained condition, which can result in a loss of foundation support for structures.

In our opinion, and consistent with the depiction on the referenced liquefaction susceptibility map, site susceptibility to liquefaction may be considered very low to negligible. The absence of a shallow groundwater table and the relatively dense, well-graded, and weakly cemented characteristics of the native glacial till soils were the primary bases for this opinion.

Fault mapping resources indicate that inferred Class B fault traces, in association with the Southern Whidbey Island Fault Zone, are located within about one-half mile both north and south of the subject site, trending in a northwest-southeast orientation. Class B faults are defined as faults for which Quaternary-age (within the past 2,588,000 years) deformation is suspected but insufficient evidence has been gathered to support the determination. The locations and activity of Class B faults are inferred based on best available data but have not been confirmed.

During the fieldwork, ESNW did not observe any evidence of faulting, deformation, or other disturbances within the native stratigraphy or surficial geomorphology. We also reviewed readily available LIDAR mapping resources for evidence of fault scarps or associated linear features on site and in the surrounding area. No evidence of surficial deformation was observed during LIDAR review.



With respect to the subject site, earthquake magnitude would be dictated by the type of earthquake event, e.g., shallow crustal, intra-plate, or subduction zone event. Although evidence of shallow faults and related lineaments have been identified throughout the Puget Sound region (Seattle Fault, South Whidbey Island Fault Zone, and others), evidence of surface fault expressions on or in the vicinity of the subject site has not been identified. In any case, seismic activity associated with a shallow crustal event would be expected to produce relatively low to moderate earthquake magnitude of relatively short duration. In terms of larger magnitude events associated with intra-plate and subduction zone events, distance between the source of these events and the site is expected to be greater. However, a longer duration of ground shaking would likely occur.

Based on the field observations and analysis outlined above, it is our opinion the risk of surface rupture during a seismic event is very low to negligible, and the site does not meet the ECC definition of a seismic hazard area.

### **Geotechnical Recommendations**

In our opinion, construction of the proposed single-family residences is feasible from a geotechnical standpoint. The geotechnical recommendations, conclusions, and considerations provided in the following sections are intended to support the proposed construction.

#### **In-situ and Imported Soil**

The in-situ soils encountered at the subject site generally have a high sensitivity to moisture and were generally in a moist condition at the time of exploration. Soils anticipated to be exposed on site will degrade if exposed to wet weather and construction traffic. Compaction of the soils to the levels necessary for use as structural fill may be difficult or impossible during wet weather conditions. Soils encountered during site excavations that are excessively over the optimum moisture content will likely require aeration or treatment prior to placement and compaction. Conversely, soils that are substantially below the optimum moisture content will require moisture conditioning (by adding water) prior to use as structural fill. An ESNW representative should be contacted to evaluate the suitability of in-situ soils for use as structural fill at the time of construction.

Imported soil intended for use as structural fill should be evaluated by ESNW during construction. The imported soil must be workable to the optimum moisture content, as determined by the Modified Proctor Method (ASTM D1557), at the time of placement and compaction. During wet weather conditions, imported soil intended for use as structural fill should consist of a well-graded, granular soil with a fines content of 5 percent or less (where the fines content is defined as the percent passing the Number 200 sieve, based on the minus three-quarter-inch fraction).

## Structural Fill

Structural fill placed and compacted during site grading activities should meet the following specifications and guidelines:

- Structural fill material Granular soil
- Moisture content At or slightly above optimum
- Relative compaction (minimum) 95 percent (Modified Proctor)
- Loose lift thickness (maximum) 12 inches

The existing soil may not be suitable for use as structural fill unless the material is at (or slightly above) the optimum moisture content at the time of placement of and compaction. Soil shall not be placed dry of the optimum moisture content and should be evaluated by ESNW during construction. A minimum relative compaction of 90 percent may be feasible for certain areas of mass grading from a geotechnical standpoint but should be evaluated by ESNW at the time of construction and confirmed with the permitting jurisdiction.

With respect to underground utility installations and backfill, local jurisdictions may dictate the soil type(s) and compaction requirements. Unsuitable material or debris must be removed from structural areas, if encountered.

## Subgrade Preparation

Following site stripping, ESNW should be contacted to observe the subgrade to confirm soil conditions are as anticipated and to provide supplementary recommendations for subgrade preparation, as necessary. Topsoil and organic-rich soils are not suitable for structural support and should be removed from areas proposed for new structural loading.

In general, weathered glacial till deposits exposed at foundation subgrades on native cut surfaces should be compacted in situ to a minimum depth of one foot below the design subgrade elevation. Uniform compaction of structural fill and the foundation and slab subgrade areas will establish a relatively consistent subgrade condition below the foundation and slab elements. Where unweathered glacial till (hardpan) soils are exposed at foundation subgrades, additional in-situ compaction is unlikely to be necessary.

Supplementary recommendations for subgrade improvement may be provided at the time of construction and would likely include further mechanical compaction or overexcavation and replacement with suitable structural fill.

## Void Space Restoration

The process of removing the existing structures may produce voids where existing foundations are removed and where crawl space areas may have been present. Complete restoration of voids from old foundation areas must be executed as part of the subgrade preparation activities. The following guidelines for preparing subgrade areas should be incorporated into the final design:

- Where voids and related demolition disturbances extend below planned subgrade elevations, restoration of these areas should be completed. Structural fill should be used to restore voids or unstable areas resulting from the removal of existing structural elements.
- Recompact, or overexcavate and replace, areas of existing fill exposed at the design subgrade elevations. Overexcavations should extend into competent native soils and structural fill should be utilized to restore subgrade elevations, as necessary.
- ESNW should confirm subgrade conditions, as well as the required level of recompaction and/or overexcavation and replacement, during site preparation activities. ESNW should also evaluate the overall suitability of prepared subgrade areas following site preparation activities.

## Foundations

The proposed residential structures can be supported on conventional spread and continuous footings bearing on undisturbed competent native soil, compacted native soil, or new structural fill placed atop a competent subgrade surface. In general, we expect competent native soil suitable for support of foundations will likely be encountered within about three feet of existing grades across the site.

Where loose or unsuitable soil conditions are encountered at foundation subgrade elevations, compaction of the soils to the specifications of structural fill or overexcavation and replacement with suitable structural fill will likely be necessary. An ESNW representative should be contacted to confirm the suitability of foundation subgrades at the time of construction.

Provided the structures will be supported as described above, the following parameters may be used for design of the new foundations:

- Allowable soil bearing capacity 2,500 psf
- Passive earth pressure 300 pcf
- Coefficient of friction 0.40

A one-third increase in the allowable soil bearing capacity can be assumed for short-term wind and seismic loading conditions. The passive earth pressure and coefficient of friction values include a safety factor of 1.5. With structural loading as expected, total settlement in the range of one inch is anticipated, with differential settlement of about one-half inch. Most of the anticipated settlement should occur during construction as dead loads are applied.

### **Slab-on-Grade Floors**

Slab-on-grade floors for the proposed residences should be supported on competent, firm, and unyielding subgrades comprised of competent native soil or compacted structural fill. Unstable or yielding subgrade areas should be recompacted or overexcavated and replaced with suitable structural fill prior to slab construction.

A capillary break consisting of at least four inches of free-draining crushed rock or gravel should be placed below each slab. The free-draining material should have a fines content of 5 percent or less (percent passing the Number 200 sieve, based on the minus three-quarter inch fraction). In areas where slab moisture is undesirable, installation of a vapor barrier below the slab should be considered. If a vapor barrier is to be utilized, it should be a material specifically designed for use as a vapor barrier and should be installed in accordance with the specifications of the manufacturer.

### **Retaining Walls**

Retaining walls must be designed to resist earth pressures and applicable surcharge loads. The following parameters may be used for retaining wall design:

- Active earth pressure (unrestrained condition) 35 pcf
- At-rest earth pressure (restrained condition) 55 pcf
- Traffic surcharge\* (passenger vehicles) 70 psf (rectangular distribution)
- Passive earth pressure 300 pcf
- Coefficient of friction 0.40
- Seismic surcharge 8H psf†

\* Where applicable.

† Where H equals the retained height (in feet).

The above passive earth pressure and coefficient of friction values include a safety factor of 1.5. Additional surcharge loading from adjacent foundations, sloped backfill, or other loads should be included in the retaining wall design. Retaining walls should be backfilled with free-draining material that extends along the height of the wall and a distance of at least 18 inches behind the wall. The upper 12 inches of the wall backfill may consist of a less permeable soil, if desired.



Drainage should be provided behind retaining walls such that hydrostatic pressures do not develop. If drainage is not provided, hydrostatic pressures should be included in the wall design. A perforated drainpipe should be placed along the base of the wall and connected to an approved discharge location. A typical retaining wall drainage detail is provided on Plate 3.

## **Drainage**

Groundwater seepage is likely to be encountered within site excavations depending on the time of year grading operations take place. Temporary measures to control surface water runoff and groundwater during construction would likely involve interceptor trenches, interceptor swales, and sumps. ESNW should be consulted during preliminary grading to identify areas of seepage and provide recommendations to reduce the potential for seepage-related instability.

Finish grades must be designed to direct surface drain water away from structures. Water must not be allowed to pond adjacent to structures. The grade adjacent to the buildings should be sloped away at a gradient of at least 2 percent for a horizontal distance of at least four feet. In our opinion, a foundation drain should be installed along building perimeter footings. A typical foundation drain detail is provided on Plate 4.

## **Infiltration Evaluation**

In general, the relatively dense, weakly cemented, and unweathered glacial till soils (hardpan) observed at depths beginning at about three feet bgs generally exhibit very poor soil infiltration characteristics.

We completed one small-scale Pilot Infiltration Test (PIT) at a depth of roughly four feet bgs at the test pit location, within a representative section of unweathered glacial till deposits. The small-scale PIT was completed in general accordance with the applicable requirements of the 2019 Stormwater Management Manual for Western Washington (2019 SWMMWW), which has been adopted by the city for flow control design. Based on the results of the PIT which yielded no measurable infiltration, in our opinion, the unweathered glacial till soils should be considered impermeable for design purposes and full infiltration is considered infeasible from a geotechnical standpoint.

If determined necessary to satisfy design objectives, small-scale (limited) infiltration devices incorporating overflow provisions may be feasible within the upper weathered glacial till soils (where present) pending further geotechnical assessment. As such, if limited infiltration devices are pursued, ESNW should review the proposal and provide supplementary recommendations, as appropriate.

## Seismic Design

The 2018 International Building Code (2018 IBC) recognizes the most recent edition of the Minimum Design Loads for Buildings and Other Structures manual (ASCE 7-16) for seismic design, specifically with respect to earthquake loads. Based on the soil conditions encountered at the test pit locations, the parameters and values provided below are recommended for seismic design per the 2018 IBC.

Parameter	Value
Site Class	C*
Mapped short period spectral response acceleration, $S_s$ (g)	1.284
Mapped 1-second period spectral response acceleration, $S_1$ (g)	0.452
Short period site coefficient, $F_a$	1.2
Long period site coefficient, $F_v$	1.5
Adjusted short period spectral response acceleration, $S_{MS}$ (g)	1.54
Adjusted 1-second period spectral response acceleration, $S_{M1}$ (g)	0.678
Design short period spectral response acceleration, $S_{DS}$ (g)	1.027
Design 1-second period spectral response acceleration, $S_{D1}$ (g)	0.452

\* Assumes very dense soil conditions, encountered to a maximum depth of eight feet bgs during the August 2023 field exploration, remain very dense to at least 100 feet bgs. Based on our experience with the project geologic setting (glacial till) across the Puget Sound region, soil conditions are likely consistent with this assumption.

## Limitations & Additional Services

This letter report has been prepared for the exclusive use of North Star Visions, LLC, and its representatives. The recommendations and conclusions provided in this letter report are professional opinions consistent with the level of care and skill that is typical of other members in the profession currently practicing under similar conditions in this area. A warranty is neither expressed nor implied. If the design assumptions outlined herein either change or are incorrect, ESNW should be contacted to review the recommendations provided in this letter report. ESNW should be contacted to review the final design to confirm that our geotechnical recommendations have been incorporated into the plans.

ESNW should be retained to provide earthwork observations and testing services during construction. Variations in the soil and groundwater conditions observed at the exploration locations may exist and may not become evident until construction. ESNW should reevaluate the conclusions provided in this letter report if variations are encountered.

We appreciate the opportunity to be of service to you and trust this letter meets your current needs. Should you have any questions, or require additional information, please call.

Sincerely,

**EARTH SOLUTIONS NW, LLC**



Brian C. Snow, L.G.  
Senior Staff Geologist



Henry T. Wright, P.E.  
Associate Principal Engineer

Attachments: Plate 1 – Vicinity Map  
Plate 2 – Test Pit Location Plan  
Plate 3 – Retaining Wall Drainage Detail  
Plate 4 – Footing Drain Detail  
Test Pit Log  
Grain Size Distribution

References:

- Geologic Map MF-1541 (Edmonds East/West Quadrangles), compiled by J.P. Minard, dated 1983
- Soil Survey of Snohomish County Area, Washington, issued July 1983
- Liquefaction Susceptibility Map of Snohomish County, compiled by S.P. Palmer, et al., dated September 2004
- Seismic Hazard Areas Map, provided by Snohomish County Planning and Development Services, dated February 1, 2016
- Edmonds City Code (ECC) Chapter 23.80
- Interactive GIS Mapping Portal, provided by City of Edmonds, Washington



Reference:  
 Snohomish County, Washington  
 OpenStreetMap.org

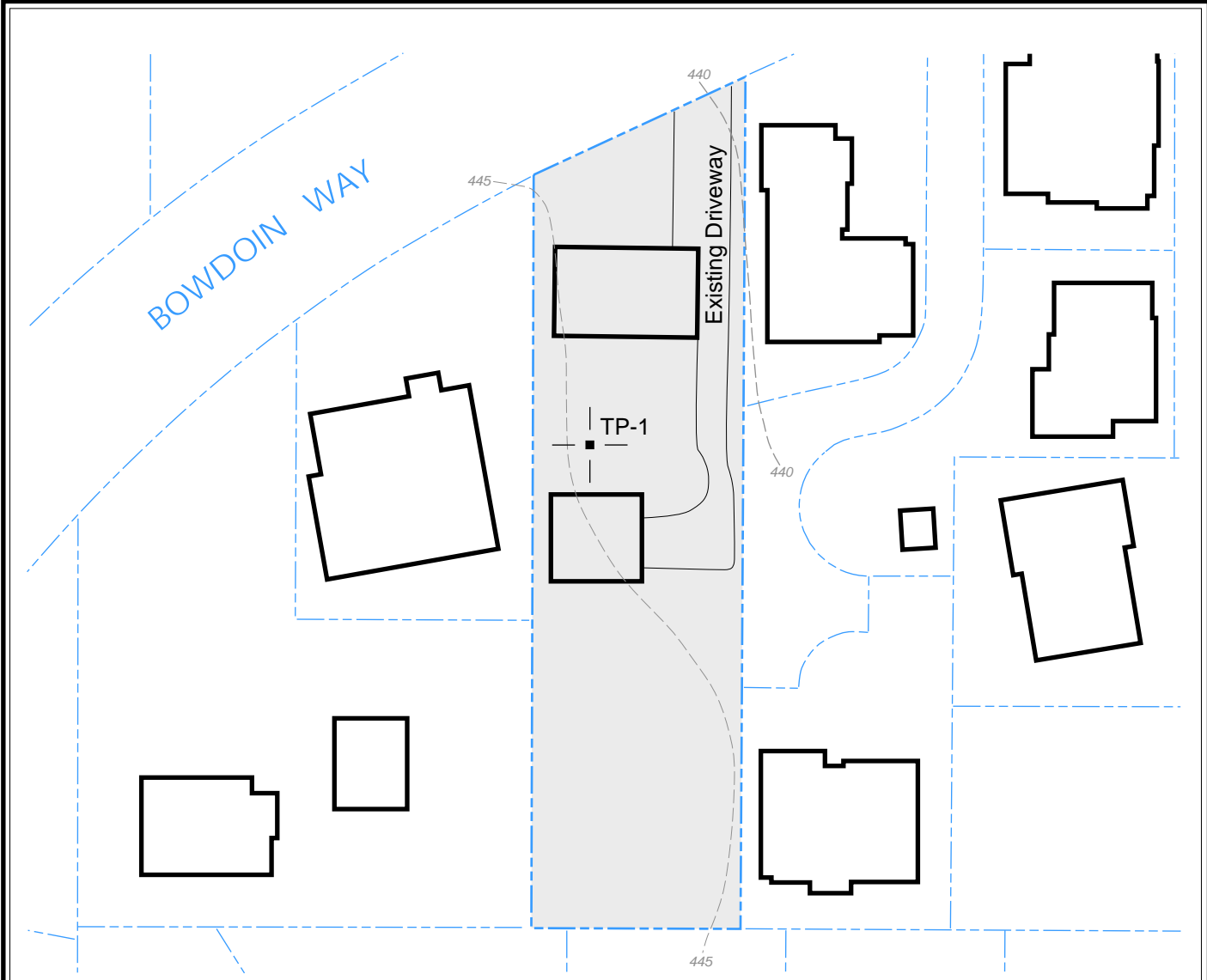
NOTE: This plate may contain areas of color. ESNW cannot be responsible for any subsequent misinterpretation of the information resulting from black & white reproductions of this plate.

**Earth Solutions NW LLC**  
 Geotechnical Engineering, Construction  
 Observation/Testing and Environmental Services

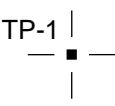


Vicinity Map  
 Nelson Residence  
 Edmonds, Washington

Drawn CAM	Date 10/26/2023	Proj. No. 9407.01
Checked BCS	Date Oct. 2023	Plate 1





**LEGEND**

- 
 TP-1 | Approximate Location of ESNW Test Pit, Proj. No. ES-9407.01, Aug. 2023
- 
 Subject Site
- 
 Existing Building



NOT - TO - SCALE

NOTE: The graphics shown on this plate are not intended for design purposes or precise scale measurements, but only to illustrate the approximate test locations relative to the approximate locations of existing and / or proposed site features. The information illustrated is largely based on data provided by the client at the time of our study. ESNW cannot be responsible for subsequent design changes or interpretation of the data by others.

NOTE: This plate may contain areas of color. ESNW cannot be responsible for any subsequent misinterpretation of the information resulting from black & white reproductions of this plate.

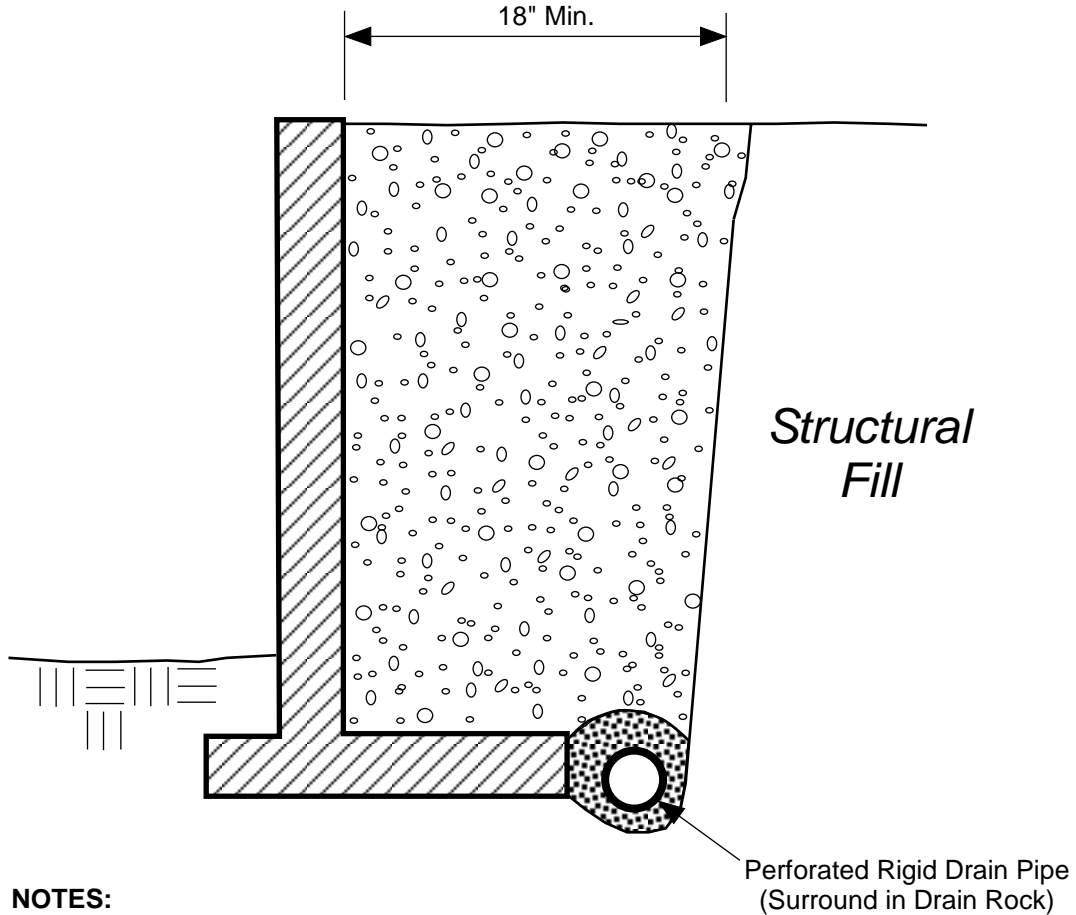


**Earth Solutions NW<sub>LLC</sub>**

Geotechnical Engineering, Construction  
Observation/Testing and Environmental Services

**Test Pit Location Plan  
Nelson Residence  
Edmonds, Washington**

Drawn CAM	Date 10/26/2023	Proj. No. 9407.01
Checked BCS	Date Oct. 2023	Plate 2

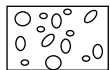


**NOTES:**

- Free-draining Backfill should consist of soil having less than 5 percent fines. Percent passing No. 4 sieve should be 25 to 75 percent.
- Sheet Drain may be feasible in lieu of Free-draining Backfill, per ESNW recommendations.
- Drain Pipe should consist of perforated, rigid PVC Pipe surrounded with 1-inch Drain Rock.

SCHEMATIC ONLY - NOT TO SCALE  
NOT A CONSTRUCTION DRAWING

**LEGEND:**

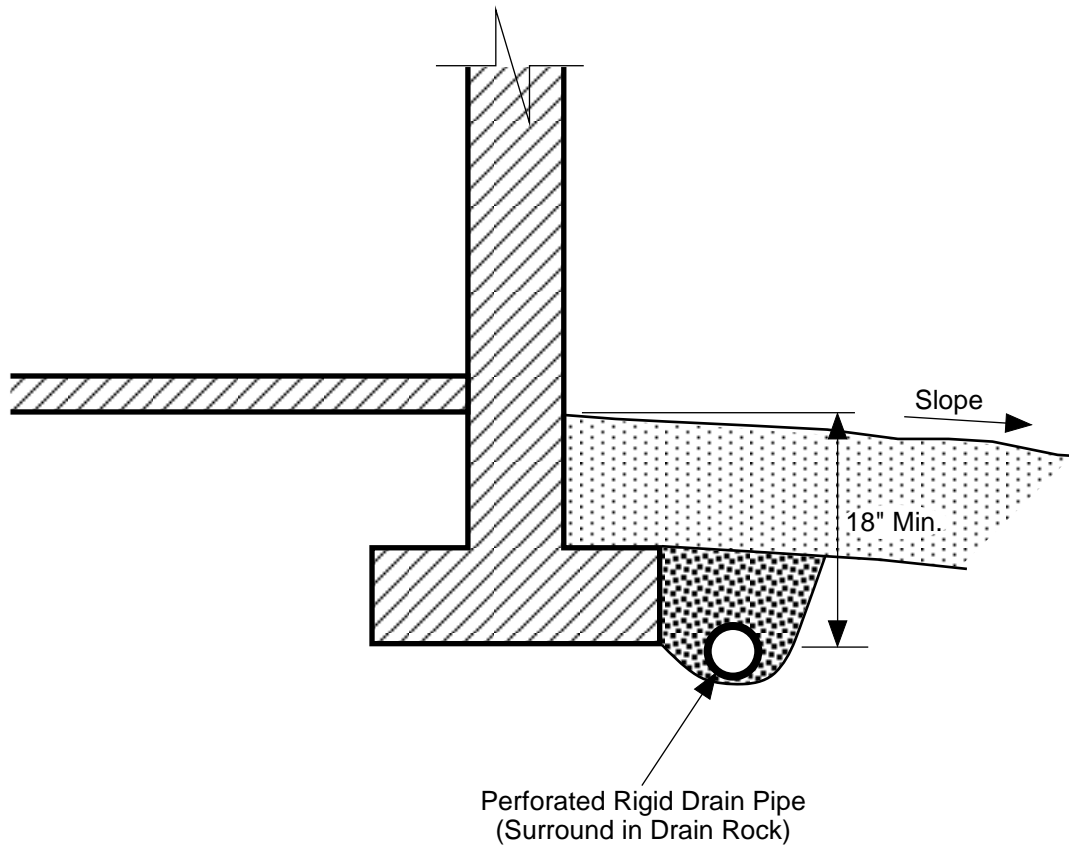


Free-draining Structural Backfill



1-inch Drain Rock

		<b>Earth Solutions NW<sub>LLC</sub></b> Geotechnical Engineering, Construction Observation/Testing and Environmental Services	
<b>Retaining Wall Drainage Detail</b> <b>Nelson Residence</b> <b>Edmonds, Washington</b>			
Drawn	CAM	Date	10/26/2023
Proj. No.	9407.01		
Checked	BCS	Date	Oct. 2023
Plate	3		

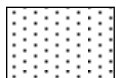


**NOTES:**

- Do NOT tie roof downspouts to Footing Drain.
- Surface Seal to consist of 12" of less permeable, suitable soil. Slope away from building.

SCHMATIC ONLY - NOT TO SCALE  
NOT A CONSTRUCTION DRAWING


**LEGEND:**



Surface Seal: native soil or other low-permeability material.



1-inch Drain Rock

	<b>Earth Solutions NW<sub>LLC</sub></b> Geotechnical Engineering, Construction Observation/Testing and Environmental Services	
	<b>Footing Drain Detail          Nelson Residence          Edmonds, Washington</b>	
Drawn CAM	Date 10/26/2023	Proj. No. 9407.01
Checked BCS	Date Oct. 2023	Plate 4

Coarse-Grained Soils - More Than 50% Retained on No. 200 Sieve		Moisture Content		Symbols	
Gravels - More Than 50% of Coarse Fraction Retained on No. 4 Sieve		<b>GW</b>	Well-graded gravel with or without sand, little to no fines	Dry - Absence of moisture, dusty, dry to the touch	
		<b>GP</b>	Poorly graded gravel with or without sand, little to no fines	Damp - Perceptible moisture, likely below optimum MC	
Sands - 50% or More of Coarse Fraction Passes No. 4 Sieve		<b>GM</b>	Silty gravel with or without sand	Moist - Damp but no visible water, likely at/near optimum MC	
		<b>GC</b>	Clayey gravel with or without sand	Wet - Water visible but not free draining, likely above optimum MC	
Sands - 50% or More of Coarse Fraction Passes No. 4 Sieve		<b>SW</b>	Well-graded sand with or without gravel, little to no fines	Saturated/Water Bearing - Visible free water, typically below groundwater table	
		<b>SP</b>	Poorly graded sand with or without gravel, little to no fines		
		<b>SM</b>	Silty sand with or without gravel		
		<b>SC</b>	Clayey sand with or without gravel		
Fine-Grained Soils - 50% or More Passes No. 200 Sieve		<b>Terms Describing Relative Density and Consistency</b>			
Silt and Clays Liquid Limit Less Than 50		<b>ML</b>	Silt with or without sand or gravel; sandy or gravelly silt	<b>Coarse-Grained Soils:</b>	
		<b>CL</b>	Clay of low to medium plasticity; lean clay with or without sand or gravel; sandy or gravelly lean clay	<b>Test Symbols &amp; Units</b>	
Silt and Clays Liquid Limit 50 or More		<b>OL</b>	Organic clay or silt of low plasticity	Density	SPT blows/foot
		<b>MH</b>	Elastic silt with or without sand or gravel; sandy or gravelly elastic silt	Very Loose	< 4
		<b>CH</b>	Clay of high plasticity; fat clay with or without sand or gravel; sandy or gravelly fat clay	Loose	4 to 9
		<b>OH</b>	Organic clay or silt of medium to high plasticity	Medium Dense	10 to 29
Highly Organic Soils		<b>PT</b>	Peat, muck, and other highly organic soils	Dense	30 to 49
		<b>FILL</b>	Made Ground	Very Dense	≥ 50
Fill		<b>Fine-Grained Soils:</b>			
		<b>Consistency</b>			
		<b>Component Definitions</b>			
		<b>Modifier Definitions</b>			
		Classifications of soils in this geotechnical report and as shown on the exploration logs are based on visual field and/or laboratory observations, which include density/consistency, moisture condition, grain size, and plasticity estimates, and should not be construed to imply field or laboratory testing unless presented herein. Visual-manual and/or laboratory classification methods of ASTM D2487 and D2488 were used as an identification guide for the Unified Soil Classification System.			








Earth Solutions NW, LLC  
 15365 N.E. 90th Street, Suite 100  
 Redmond, Washington 98052  
 Telephone: 425-449-4704  
 Fax: 425-449-4711

# TEST PIT NUMBER TP-1

PROJECT NUMBER ES-9407.01 PROJECT NAME Nelson Residence  
 DATE STARTED 8/14/23 COMPLETED 8/14/23 GROUND ELEVATION 445 ft  
 EXCAVATION CONTRACTOR NW Excavating LATITUDE 47.80591 LONGITUDE -122.34856  
 LOGGED BY BCS CHECKED BY HTW GROUND WATER LEVEL:  
 NOTES \_\_\_\_\_  $\nabla$  AT TIME OF EXCAVATION \_\_\_\_\_  
 SURFACE CONDITIONS Lawn grass AFTER EXCAVATION \_\_\_\_\_

DEPTH (ft)	SAMPLE TYPE NUMBER	TESTS	U.S.C.S.	GRAPHIC LOG	MATERIAL DESCRIPTION
0.0					
			TPSL		Dark brown TOPSOIL and SOD 444.6
					Brown silty SAND with gravel, medium dense to dense, damp to moist
	GB	MC = 7.6 Fines = 32.2			[USDA Classification: gravelly sandy LOAM]
2.5					-probed 3" -becomes gray, very dense, weakly cemented
	GB	MC = 8.6 Fines = 34.6	SM		-infiltration test at 4' [USDA Classification: slightly gravelly sandy LOAM]
5.0					-difficult excavation
	GB	MC = 10.0			
7.5					
	GB	MC = 7.9 Fines = 38.4			[USDA Classification: gravelly sandy LOAM] 437.0

Test pit terminated at 8.0 feet below existing grade. No groundwater encountered during excavation. No caving observed.

LIMITATIONS: Ground elevation (if listed) is approximate; the test location was not surveyed. Coordinates are approximate and based on the WGS84 datum. Do not rely on this test log as a standalone document. Refer to the text of the geotechnical report for a complete understanding of subsurface conditions.

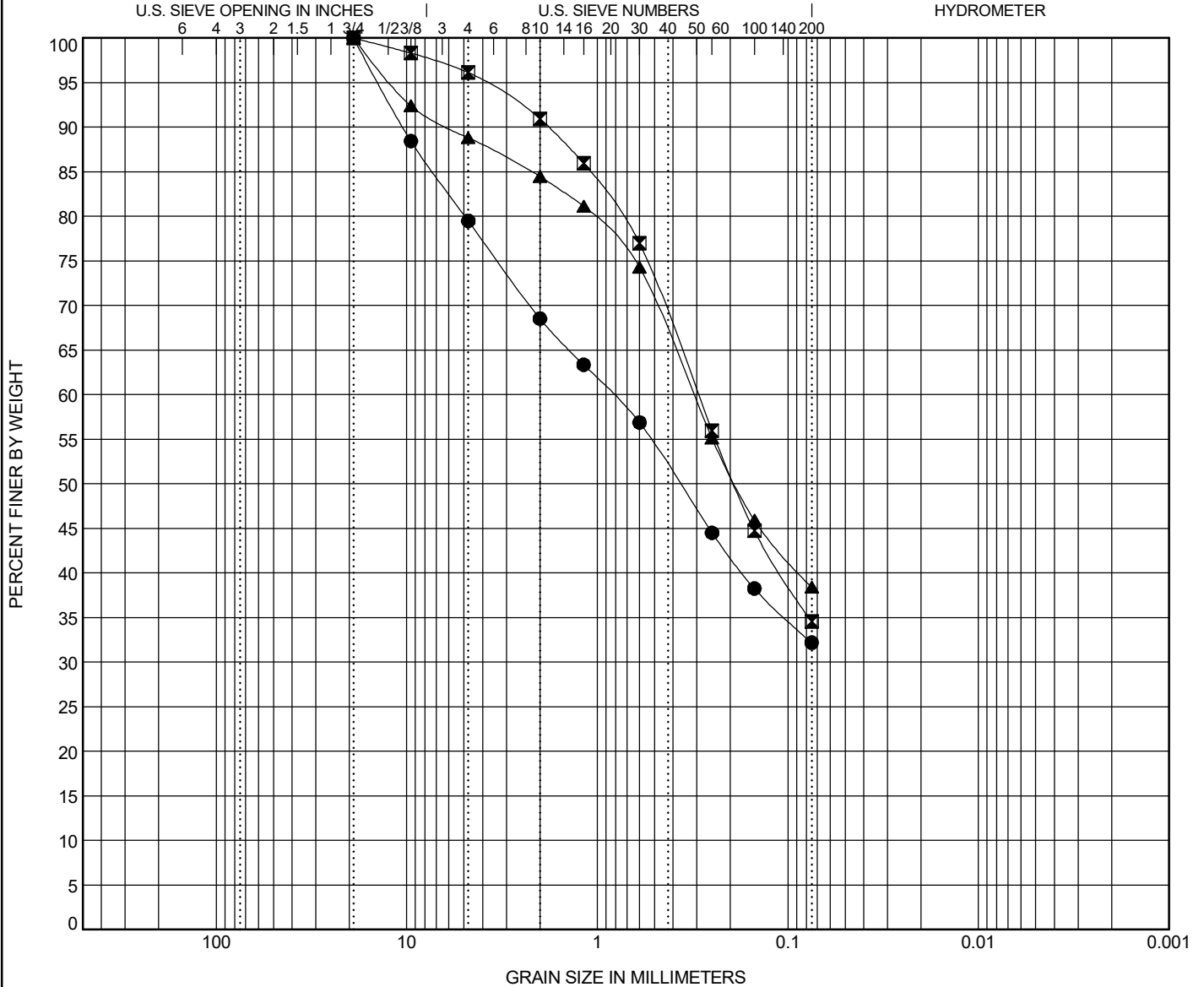


Earth Solutions NW, LLC  
 15365 N.E. 90th Street, Suite 100  
 Redmond, Washington 98052  
 Telephone: 425-449-4704  
 Fax: 425-449-4711

# GRAIN SIZE DISTRIBUTION

PROJECT NUMBER ES-9407.01

PROJECT NAME Nelson Residence



COBBLES	GRAVEL		SAND			SILT OR CLAY
	coarse	fine	coarse	medium	fine	

Specimen Identification	Classification					Cc	Cu
● TP-01 1.50ft.	USDA: Brown Gravelly Sandy Loam. USCS: SM with Gravel.						
☒ TP-01 4.00ft.	USDA: Gray Slightly Gravelly Sandy Loam. USCS: SM.						
▲ TP-01 8.00ft.	USDA: Gray Gravelly Sandy Loam. USCS: SM.						

Specimen Identification	D100	D60	D30	D10	LL	PL	PI	%Silt	%Clay
● TP-01 1.5ft.	19	0.83						32.2	
☒ TP-01 4.0ft.	19	0.296						34.6	
▲ TP-01 8.0ft.	19	0.312						38.4	

GRAIN SIZE USDA ES-9407.01 NELSON RESIDENCE.GPJ GINT US LAB.GDT 10/16/23



**RECEIVED**

Feb 22 2024

CITY OF EDMONDS  
DEVELOPMENT SERVICES  
DEPARTMENT

PLN2024-0015



**Jurisdiction:**Edmonds

**Project Name:** Nelson Short Plat

**Application ID:** 1368720

**Supplemental Name: Applicant Certification - Planning**

The applicant, and his/her/its heirs, and assigns, in consideration on the processing of the application agrees to release, indemnify, defend and hold the City of Edmonds harmless from any and all damages, including reasonable attorney's fees, arising from any action or infraction based in whole or part upon false, misleading, inaccurate or incomplete information furnished by the applicant, his/her/its agents or employees. The property affected by the application is in the exclusive ownership of the applicant or that the application has been submitted with the consent of all owners of the affected property.

I certify, under the penalty of perjury under the laws of the State of Washington, that the information and exhibits herewith submitted are true and correct to the best of my knowledge and that I am authorized to file this application on behalf of the owner of the subject property.

I do so certify.



# RESIDENCE

## LEGEND

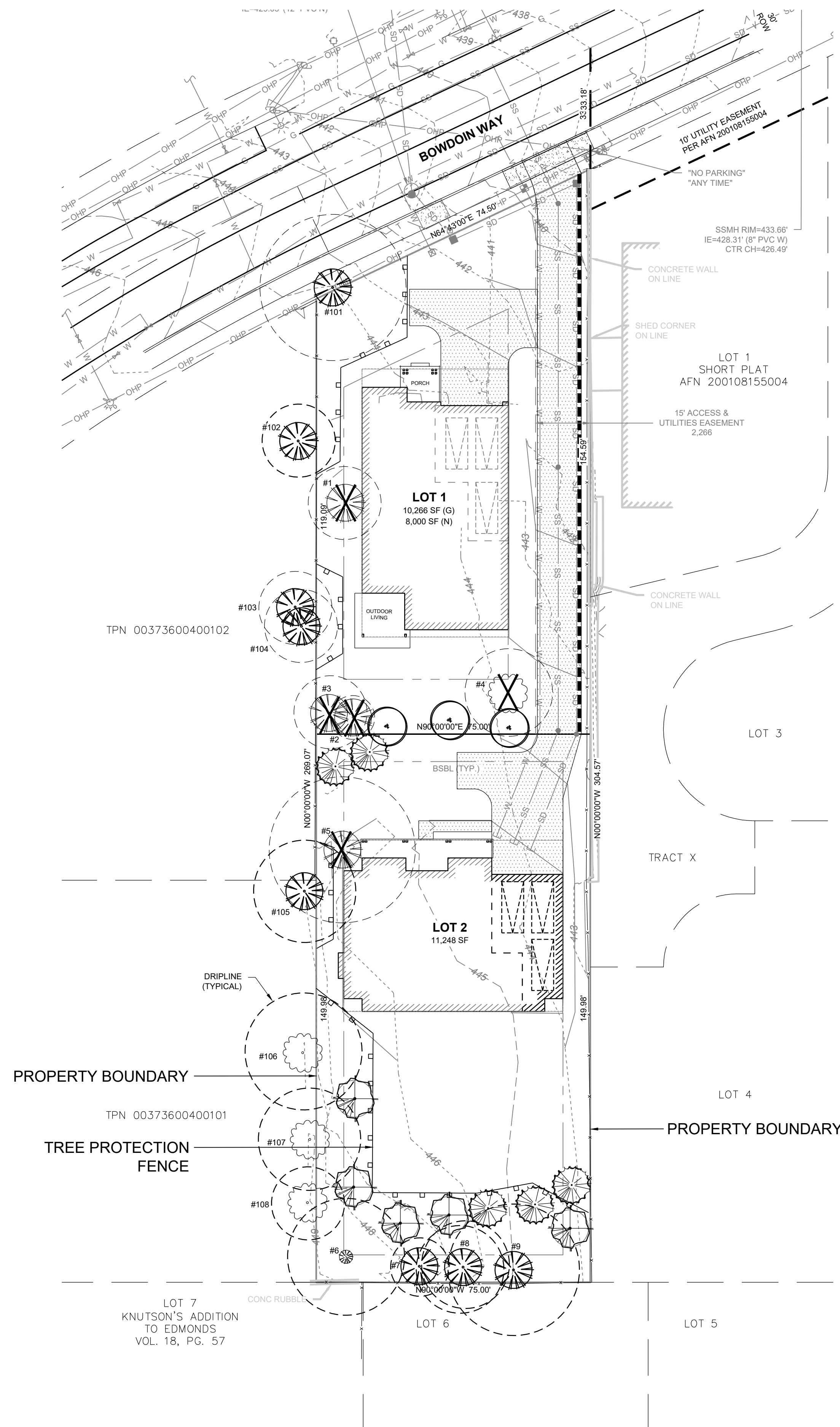
- EXISTING DECIDUOUS TREE TO BE RETAINED (DRIPLINE IS DASHED LINE)
- EXISTING DECIDUOUS TREE TO BE REMOVED
- EXISTING EVERGREEN TREE TO BE RETAINED
- EXISTING EVERGREEN TREE TO BE REMOVED
- TREE PROTECTION FENCING. SEE ARBORIST REPORT FOR ADDITIONAL INFORMATION

Tree/Tag #	Species Common name	Species Scientific name	DBH (inches)	Height (feet)	Drip-Line/Limits of Disturbance (feet)				Health Condition	Structural Condition	Comments	Proposal	Replacement Trees	
					N	S	E	W					Required	Provided
1	Lawson cypress	<i>Chamaecyparis lawsoniana</i>	14.13.8 (35)	62	12	9	11	8	Excellent	Fair	forked at base, included bark	Remove	3	
2	Lawson cypress	<i>Chamaecyparis lawsoniana</i>	9	40	6	6	6	2	Good	Fair	natural lean	Remove	1	
3	Lawson cypress	<i>Chamaecyparis lawsoniana</i>	15.9.6 (30)	48	10	10	8	10	Excellent	Good	cluster	Remove	3	
4	Japanese maple	<i>Acer palmatum</i>	10.6.6 (22)	20	18	12	14	16	Good	Good	typical form	Remove	3	
5	Western red cedar	<i>Thuja plicata</i>	36.32 (68)	90	18	20	22	16	Excellent	Fair	forked at base, seam, natural leans	Remove	3	
6	Sitka spruce	<i>Picea sitchensis</i>	38	100	12/14	16	14	16	Good	Good	trunk forks at 8 feet, sound attachment	Retain		
7	Lawson cypress	<i>Chamaecyparis lawsoniana</i>	11.8 (19)	52	8/10	6	4	6	Excellent	Fair	forked at base	Retain		
8	Lawson cypress	<i>Chamaecyparis lawsoniana</i>	17.14 (31)	78	10/12	8	6	6	Excellent	Good	typical form	Retain		
9	Western red cedar	<i>Thuja plicata</i>	34.22 (56)	88	18/18	16	18	16	Good	Good	forked trunk, sound attachment, forked top leaders	Retain		
OFF-SITE TREES														
101	Western red cedar	<i>Thuja plicata</i>	7 - 18 to 24"	80	18	20/20	20/18	18	Good	Fair	multiple (7) trunks, moderate included bark	Protect		
102	Lawson cypress	<i>Chamaecyparis lawsoniana</i>	16, 15, 13, 12	56	10	10	10/10	10	Excellent	Good	cluster	Protect		
103	Western red cedar	<i>Thuja plicata</i>	28	72	12	10	12/12	8	Good	Excellent	close to fence	Protect		
104	Western red cedar	<i>Thuja plicata</i>	28	70	8	12	8/10	14	Excellent	Excellent	close to fence	Protect		
105	Douglas fir	<i>Pseudotsuga menziesii</i>	26	96	6	14	10/10	12	Excellent	Good	natural lean SW	Protect		
106	English walnut	<i>Juglans regia</i>	16	52	18	16	14/14	NA	Good	Good	no concerns	Protect		
107	red oak	<i>Quercus rubra</i>	13	55	10	10	14/12	NA	Good	Good	no concerns	Protect		
108	bitter cherry	<i>Prunus emarginata</i>	11	56	8	10	12/10	NA	Good	Fair	forked trunk, weak attachment	Protect		
Dripline and Limits of Disturbance measurements from face of trunk For trees with multiple leaders at four and one-half feet height, the DBH shall be the combined cumulative total of branches greater than six inches diameter at four and one-half feet above the average grade.														

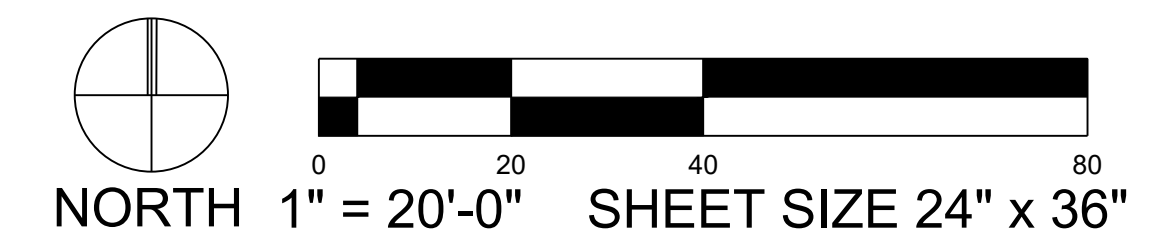
13 REPLACEMENT TREES REQUIRED  
13 REPLACEMENT TREES PROVIDED

## PLANT SCHEDULE

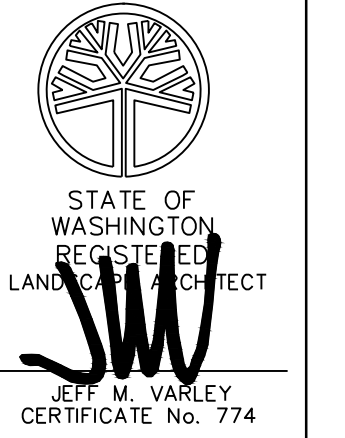
SYMBOL	BOTANICAL/COMMON NAMES	SIZE	QUANTITY	REMARKS
<b>REPLACEMENT TREES:</b>				
	THUJA PLICATA / WESTERN RED CEDAR*	6'-7" HT. B & B	5	FULL AND MATCHING. UN-CUT LEADER. STAKE AND GUY FOR ONE YEAR
	PSEUDOTSUGA MENZIESII / DOUGLAS FIR*	6'-7" HT. B & B	5	FULL AND MATCHING. UN-CUT LEADER. STAKE AND GUY FOR ONE YEAR
	ACER CIRCINATUM / VINE MAPLE*	1.5" CAL. B & B, MULTI-STEM	3	FULL AND MATCHING. MIN. 3 STEMS. STAKE AND GUY FOR ONE YEAR
	*NATIVE TREE		13	



TREE INFORMATION SOURCE: 2/1/2024 TREE REPORT BY LAYTON TREE CONSULTING



NO.	DATE	DESCRIPTION	BY



**VARLEY • VARLEY • VARLEY**  
landscape architect  
JEFF VARLEY  
19819 30th Drive SE Bothell, Washington 98012  
email: jeff@hotmail.com phone: 425-468-9430  
www.varleylandscape.com

RESIDENCE  
8514 BOWDOIN WAY, EDMONDS  
PARCEL NO: 00613400000100  
REPLACEMENT TREE PLAN

PLN2024-0015

**RECEIVED**  
Feb 22 2024  
CITY OF EDMONDS  
DEVELOPMENT SERVICES  
DEPARTMENT

JOB NUMBER:	
DRAWING NAME:	
DESIGNER:	JMV
DRAFTING BY:	JMV
DATE:	2.14.24
SCALE:	AS SHOWN
JURISDICTION:	EDMONDS

**L-1**  
SHEET 1 of 1



**Layton Tree Consulting LLC**

For: Village Life  
Site: 8514 Bowdoin Way

**Tree Summary Table**

Date: 1/5/2024



Tree/ Tag #	Species Common name	Species Scientific name	DBH (inches)	Height (feet)	Drip-Line/Limits of Disturbance (feet)				Health Condition	Structural Condition	Comments	Replacement Trees Proposal	Replacement Trees Required
					N	S	E	W					
1	Lawson cypress	<i>Chamaecyparis lawsoniana</i>	14,13,8 (35)	62	12	9	11	8	Excellent	Fair	forked at base, included bark	Remove	3
2	Lawson cypress	<i>Chamaecyparis lawsoniana</i>	9	40	6	6	6	2	Good	Fair	natural lean	Remove	1
3	Lawson cypress	<i>Chamaecyparis lawsoniana</i>	15,9,6 (30)	48	10	10	8	10	Excellent	Good	cluster	Remove	3
4	Japanese maple	<i>Acer palmatum</i>	10,6,6 (22)	20	18	12	14	16	Good	Good	typical form	Remove	3
5	Western red cedar	<i>Thuja plicata</i>	36,32 (68)	90	18	20	22	16	Excellent	Fair	forked at base,seam,natural leans	Remove	3
6	Sitka spruce	<i>Picea sitchensis</i>	38	100	12/14	16	14	16	Good	Good	trunk forks at 8 feet,sound attachment	Retain	
7	Lawson cypress	<i>Chamaecyparis lawsoniana</i>	11,8 (19)	52	8/10	6	4	6	Excellent	Fair	forked at base	Retain	
8	Lawson cypress	<i>Chamaecyparis lawsoniana</i>	17,14 (31)	78	10/12	8	6	6	Excellent	Good	typical form	Retain	
9	Western red cedar	<i>Thuja plicata</i>	34,22 (56)	88	18/18	16	18	16	Good	Good	forked trunk, sound attachment, forked top leaders	Retain	
													13
OFF-SITE TREES													
101	Western red cedar	<i>Thuja plicata</i>	7 - 18 to 24"	80	18	20/20	20/18	18	Good	Fair	multiple (7) trunks, moderate included bark	Protect	
102	Lawson cypress	<i>Chamaecyparis lawsoniana</i>	16,15,13,12	56	10	10	10/10	10	Excellent	Good	cluster	Protect	
103	Western red cedar	<i>Thuja plicata</i>	28	72	12	10	12/12	8	Good	Excellent	close to fence	Protect	
104	Western red cedar	<i>Thuja plicata</i>	28	70	8	12	8/10	14	Excellent	Excellent	close to fence	Protect	
105	Douglas fir	<i>Pseudotsuga menziesii</i>	26	96	6	14	10/10	12	Excellent	Good	natural lean SW	Protect	
106	English walnut	<i>Juglans regia</i>	16	52	18	16	14/14	NA	Good	Good	no concerns	Protect	
107	red oak	<i>Quercus rubra</i>	13	55	10	10	14/12	NA	Good	Good	no concerns	Protect	
108	bitter cherry	<i>Prunus emarginata</i>	11	56	8	10	12/10	NA	Good	Fair	forked trunk, weak attachment	Protect	

Drip-line and Limits of Disturbance measurements from face of trunk

For trees with multiple leaders at four and one-half feet height, the DBH shall be the combined cumulative total of branches greater than six inches diameter at four and one-half feet above the average grade.